

CYLINDRO II LED WITH OPAL ACRYLIC DIFFUSER

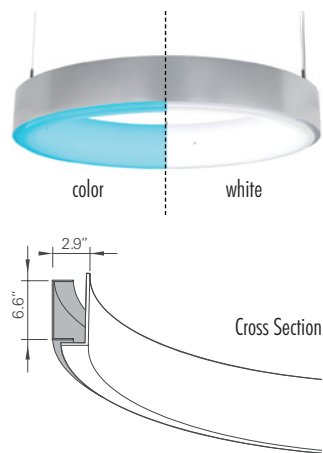

TYPE:

PROJECT:

ORDER NUMBER:

Model#	Finish	LEDs	Dimming	Mount
6703-3 ft.	S-Silver	Red	BDMXMOD	S-Separate
6704-4 ft.	W-White	Blue		SR-Separate Remote
6705-5 ft.	K-Black	SQ-RGB		CS-Central Standard
				CR-Central Remote
6713-3 ft., LO	S-Silver	W30	BDIM-W1	SCR-Sputnick Central
6714-4 ft., LO	W-White	W35	BDIM-W2	SREM-Separate EM
6715-5 ft., LO	K-Black	W40	BDIM-W11	CREM-Central EM
6723-3 ft., HO				
6724-4 ft., HO				
6725-5 ft., HO				

STANDARD CANOPY

- Mounts to all standard JBoxes.
- Specify **Separate** (10" x 2.25") or **Central** (14" x 2.25") mount. For remote driver installation, see p. 2.

CONSTRUCTION

- Extruded aluminum outer housing with white frosted acrylic diffuser. 6' adjustable power cord and AC cables with push button grippers supplied standard. (Specify **XP** for additional length.)

LED DRIVERS

- Constant voltage, 100W/24V universal for **SQ**-RGB DMX.
- 60W/12V driver for single color (Red or Blue) LEDs.
- Electronic drivers, DMX and dimmer interface housed in canopy or remote gear box for easy access.
- Color LED options include red and blue, as well as RGB sequencing, controlled with a DMX 512 interface (**BDMXMOD**). Optional wall box control offered separately (see Traxon, back page.)
- cUL listed for dry locations.

COLOR LEDs

- Flexible 5050 universal voltage LED tape light.
- 24V for **SQ**-RGB sequencer; 12V for single color (Red or Blue) LEDs.

WHITE LEDs

- Nichia Corp. NFSL757 linear board chips, available in 6W per foot (**LO**-Low Output), or 11.2W per foot (**HO**-High Output).
- White color temperatures include **W30** (3000K), **W35** (3500K), and **W40** (4000K).
- cUL listed for dry locations only.

Example:

6725 | S | W35 | BDIM-W2 | SREM

- BTRAXW**-Traxon Light Drive, white* (order separately) Enter quantity: _____
- RBRD**-red braided cord (see p. 2).

Model	Length	Red/Blue Watts	SQ Watts	
6703	3 ft.	18	36	6713-3 ft., 54W (LO)
6704	4 ft.	27	54	6714-4 ft., 72W (LO)
6705	5 ft.	36	72	6715-5 ft., 90W (LO)
				6723-3 ft., 99W (HO)
				6724-4 ft., 132W (HO)
				6725-5 ft., 165W (HO)

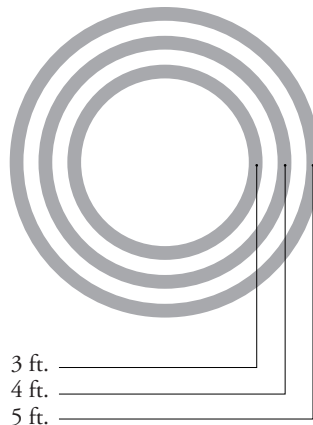
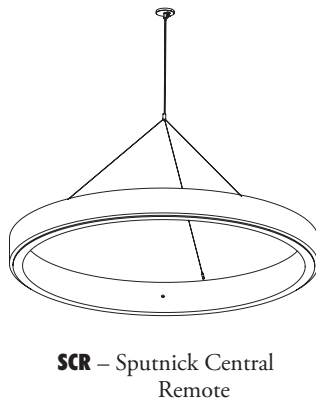
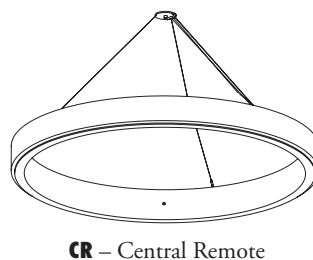
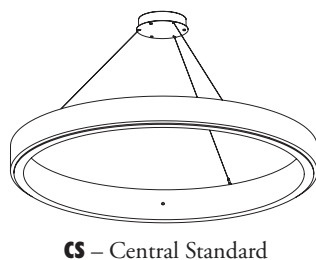
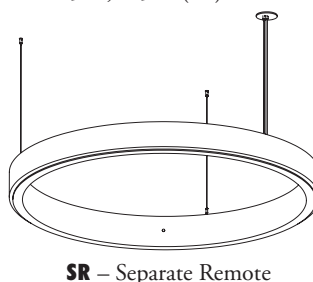
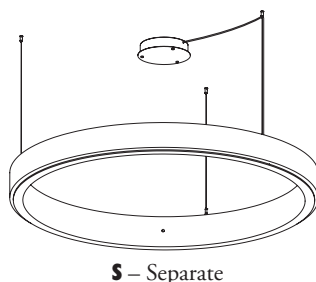

CYLINDRO II

BURBANK,
CALIFORNIA,
91505
WWW.
DELRAY
LIGHTING.
COM

LED

6725.W30

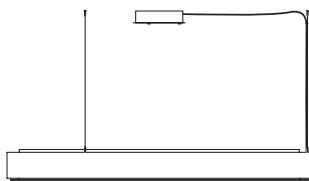

CP DISTRIBUTION

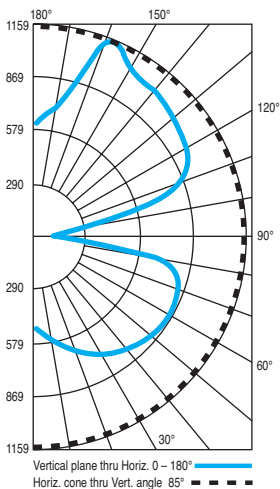

COEFFICIENTS

% CEILING 80	(20% FLOOR)		
	% WALL 70	50	30
0	107	107	107
1	95	89	84
2	85	76	68
3	76	65	56
4	69	57	48
5	63	50	41
6	57	44	35
7	53	39	31
8	49	36	27
9	45	32	24
10	42	29	22

NOTES

6725.W30

219W LED strip, 3000°K
 Total lumens: 9,300
 CRI: 90.0
 R9 ≥ 50.0

LM-79 – 6725.W30

Driver:	Philips Advance
Total Lumens:	5,580
Input Voltage (VAC/60Hz):	120
Input Power (W):	132
Input Power Factor:	>.99
Efficacy:	42
CRI:	90
Correlated Color Temp (°K):	3,224

REMOTE DRIVERS

Driver must be accessible after installation. For suspended and hard lid ceilings with access panels. Canopy mounts to mud ring attached to J-box.

NOTE: Multiple drivers must be mounted no less than 4 inches apart side-by-side, and 1 inch apart end-to-end, to avoid overheating.



Remote Driver Canopy
 3.8 x 0.45 in.

Max. Wiring Distance (at full load)

Wire Size (AWG)	Distance (ft.)
18	18
16	29
14	46
12	71
10	120

SR – Separate mount driver installation.

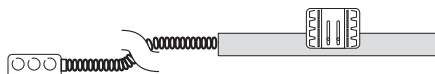

CR – Central mount remote driver installation.

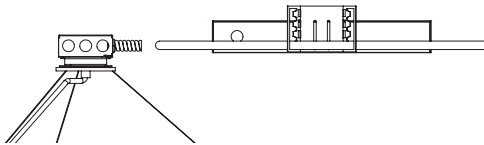

SR/EM or **CR/EM** – Separate or Central Emergency. *T-bar install shown, below.*

Emergency battery pack provides 7W for 90 minutes. (12W also available.) Remote install only. Red driver light and test switch mounted in handy box installed at ceiling.

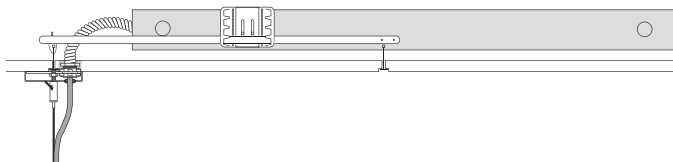

WATTAGE / LUMENS

Model No.	Diameter	Watts	Lumens	Drivers	Canopy
6713	3'	66	2790	1	*
6714	4'	87	3683	1	*
6715	5'	128	5400	2	**
6723	3'	132	5600	2	**
6724	4'	176	7400	2	**
6725	5'	219	9300	2	**

Canopy Dimensions

* Single Driver for **6713** and **6714**: 11" OD x 2.296" height

** Dual Driver for **6715**, **6723**, **6724** and **6725**: 14.5" OD x 2.205" height

ACRYLIC DIFFUSER CLEANING

Warning: Do not clean with ammonia based cleaners (e.g. Windex®). Use only water or cleaners specifically formulated for cleaning plastics.

AIRCRAFT CABLE

Note: Aircraft cable suspension not recommended for outdoor use, where fixture will be exposed to water, or subject to wind oscillation. Avoid use near HVAC vents and in environments with corrosive chemical vapors, such as swimming pools.

OPTIONS

DIMMING DRIVERS

• For white LEDs only.

BDIM-W1

- 0–10V dimming to 10%.
- Utilizes 100W/24V, 0–10V 120/277 constant voltage driver.
- Use with 0–10V, purple/gray wire analog dimmers; with low end trim pot, and adjust low end to above flicker threshold.

BDIM-W2

- 0–10V dimming to 1%.
- System utilizes 100W/24V, 120/277 constant voltage driver, with the Eldo LIN211D1-LN module.
- Required for use with digital architecture/networking systems like Acuity nLight, Eaton Greengate, and similar management systems.

BDIM-W11

- Lutron LD3096W24U dimming driver module.
- 0.1% dimming and fade-to-off, with Lutron dimming systems.
- For remote driver install only.

RGB OPTIONS

BDMXMOD

- Osram part no. OTDMXRGB supplied.
- DMX control interface for RGB LED.
- Provides DMX control with protocols that meet USITT DMX-512A or DMX512 (DIN 56930-2). No converter is required. DMX controls by others.
- A second 4-conductor control cable to fixture canopy is supplied.

TRAXON LIGHT-DRIVE RGB

(order separately)

BTRAXW – white controller

- Standalone, wall-mounted (12V power supply included) DMX controller for RGB LED that provides direct access to fixtures.
- Tune color and brightness with the Light-Drive wheel.
- See www.traxon-usa.com for details.

RED BRAIDED CORD

Red braided power cord.
 Order **RBRD**.

