

# FINELITE

## Series 18 Technical Sheet

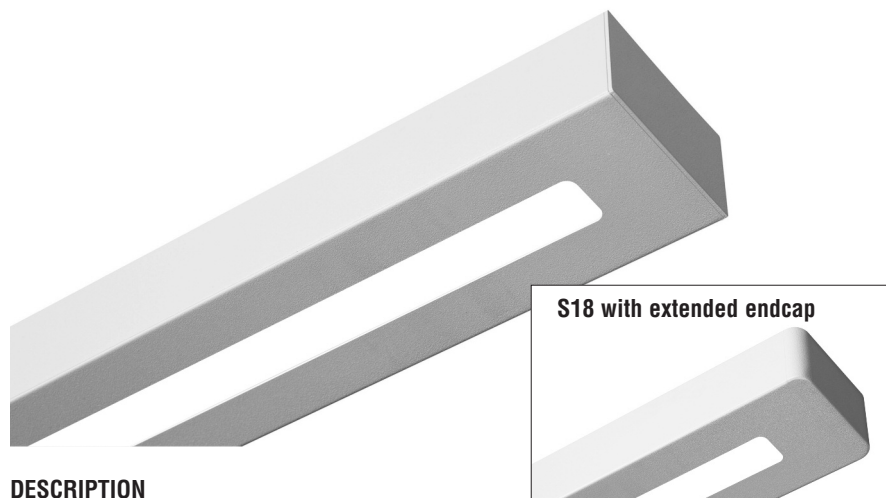

### DESCRIPTION

Series 18 is a slim profile rectilinear form scaled to complement any interior room. At just 4" by 2.25" this luminaire integrates exceptionally well into low ceiling environments.

Date

Project

Type

Comments

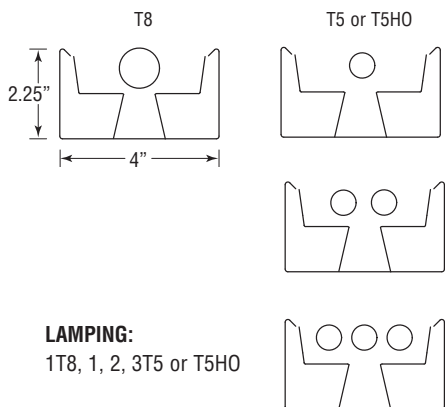

**LAMPING:**  
1T8, 1, 2, 3T5 or T5HO

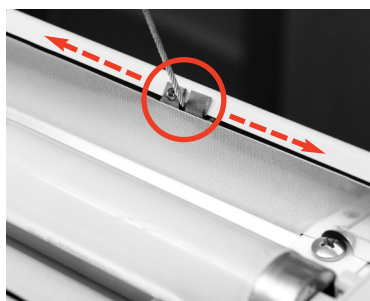

**OPTIONAL FLEXIBLE MOUNTING BRACKET:**  
The Flexible Mounting Bracket (FM) adjusts along the length of the luminaire to accommodate existing mounting points.

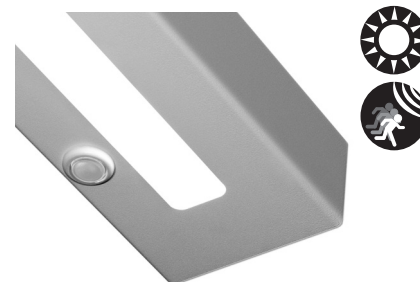

**INTEGRATED SENSORS:**  
Series 18 can be specified with integrated daylight or occupancy sensors.

### ORDERING GUIDE

Sample Number: S18 - 32' - 1T8 - SC - EP - 120 - FA - EE - C1 - 0.88 - OBD

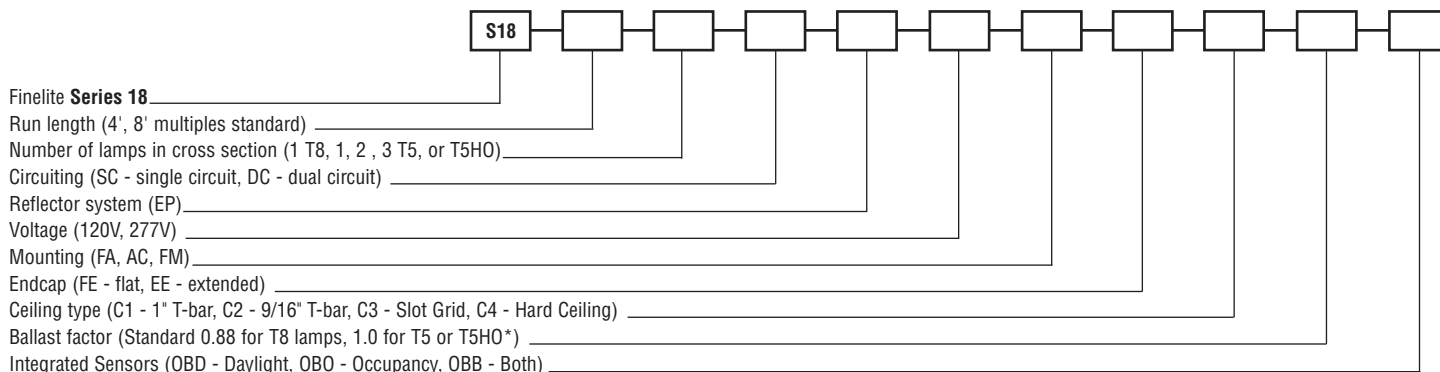

Finelite **Series 18** \_\_\_\_\_  
 Run length (4', 8' multiples standard) \_\_\_\_\_  
 Number of lamps in cross section (1 T8, 1, 2, 3 T5, or T5HO) \_\_\_\_\_  
 Circuiting (SC - single circuit, DC - dual circuit) \_\_\_\_\_  
 Reflector system (EP) \_\_\_\_\_  
 Voltage (120V, 277V) \_\_\_\_\_  
 Mounting (FA, AC, FM) \_\_\_\_\_  
 Endcap (FE - flat, EE - extended) \_\_\_\_\_  
 Ceiling type (C1 - 1" T-bar, C2 - 9/16" T-bar, C3 - Slot Grid, C4 - Hard Ceiling) \_\_\_\_\_  
 Ballast factor (Standard 0.88 for T8 lamps, 1.0 for T5 or T5HO\*) \_\_\_\_\_  
 Integrated Sensors (OBD - Daylight, OBO - Occupancy, OBB - Both) \_\_\_\_\_

\*Contact factory for available ballast factors

# FINELITE

## Series 18 Technical Sheet

### PHOTOMETRY

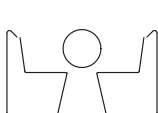

**S18: 1 T8-EP**  
 Distribution: 83% Up / 17% Down  
 Efficiency: 91.6%  
 Peak Candela Value: 709@ 145°  
 LSI Report: 29535

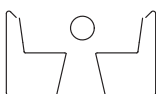
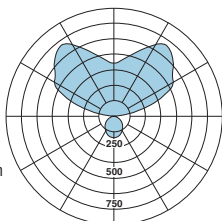

**S18: 1 T5HO-EP**  
 Distribution: 84% Up / 16% Down  
 Efficiency: 96.4%  
 Peak Candela Value: 1204@ 135°  
 LSI Report: 29349

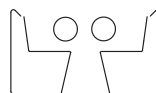
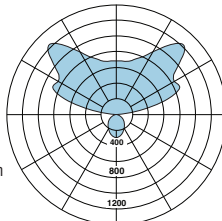

**S18: 2 T5-EP**  
 Distribution: 86% Up / 14% Down  
 Efficiency: 92.1%  
 Peak Candela Value: 1370@ 145°  
 LSI Report: 29536

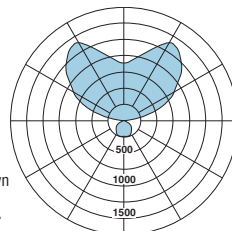

CANDLEPOWER SUMMARY						
	0	22.5	45	67.5	90.0	Flux
0	176	176	176	176	176	
5	175	175	175	176	175	17
15	168	167	167	167	166	47
25	153	153	149	145	143	68
35	132	131	124	119	117	78
45	107	105	99	97	95	77
55	80	79	76	75	74	69
65	55	54	54	51	50	52
75	35	32	30	28	27	32
85	9	8	7	7	7	9
90	0	0	0	0	0	
95	19	57	54	55	54	61
105	80	211	266	257	251	237
115	151	330	411	480	488	377
125	220	391	518	554	571	417
135	284	410	597	650	665	410
145	339	422	568	676	709	342
155	383	432	512	585	610	235
165	413	433	471	496	508	132
175	430	429	435	438	441	43
180	428	428	428	428	428	

CANDLEPOWER SUMMARY						
	0	22.5	45	67.5	90.0	Flux
0	295	295	295	295	295	
5	294	293	292	293	291	28
15	280	278	271	265	260	76
25	253	247	229	217	211	106
35	215	205	183	173	170	118
45	170	160	143	138	136	114
55	125	118	108	104	101	99
65	86	80	75	70	68	75
75	53	44	41	38	37	44
85	15	13	11	10	9	13
90	0	0	0	0	0	
95	27	115	91	69	65	114
105	124	316	546	577	576	466
115	239	540	626	813	883	624
125	351	548	911	878	882	664
135	455	562	914	1168	1204	661
145	545	589	777	985	1066	497
155	616	626	712	795	824	331
165	666	670	680	699	711	195
175	693	688	691	689	690	67
180	690	690	690	690	690	

CANDLEPOWER SUMMARY						
	0	22.5	45	67.5	90.0	Flux
0	237	237	237	237	237	
5	237	236	237	239	238	23
15	228	231	238	244	244	67
25	210	217	226	228	226	102
35	185	194	194	189	185	119
45	153	160	153	148	146	118
55	117	120	114	113	112	103
65	83	81	80	75	74	78
75	53	47	42	39	37	45
85	13	11	8	6	5	11
90	0	0	0	0	0	
95	28	79	64	47	42	80
105	152	340	405	400	396	374
115	297	593	670	735	748	620
125	440	775	928	965	969	753
135	574	818	1134	1190	1218	778
145	689	849	1164	1338	1370	682
155	779	869	1044	1200	1260	479
165	842	880	952	1010	1036	269
175	876	877	891	896	900	87
180	874	874	874	874	874	

— Refer to [www.finelite.com](http://www.finelite.com) for additional photometry and product information.

### SPECIFICATIONS

**CONSTRUCTION:** Body is 20-gauge die-formed steel with 18-gauge die-formed internal joiner system, plug-together wiring standard. All components are hard-tooled to tolerances of 0.010".

**ENDCAPS:** (FE) Flat endcap, 14 gauge dieformed steel, adds 0.1 at each end. **Optional:** (EE) Extended endcap, aluminum die-cast endcap, adds 0.55" at each end.

**REFLECTORS:** Semi-specular Aluminum 94% reflective.

**DOWNLIGHT SHIELDING OPTIONS:**

Diffuse Center Optic (DCO) standard. 73% transmissive, 99% diffusion.

**ACCESSORY:** Optional Dust Cover for T5 only, clear acrylic. Contact factory.

**NOTE:** Will significantly impact light level performance. Contact Factory.

**ELECTRICAL:** 120 or 277V prewired. Fixture and electrical components are UL/C-UL listed and fixture will bear UL/C-UL labels. **Optional Adders:** prewired dual circuit, emergency circuits, low-profile emergency battery packs. Contact factory.



**INTEGRATED SENSORS:** S18 can be specified with integrated sensors from Wattstopper, Philips, and Lutron.

**Daylight Sensors:** Wattstopper sensors can be supplied with either a closed loop 0-10v dimming (handheld remote supplied) or closed loop single zone switching system. The Lutron sensor is directional and for use with Ecosystem ballasts. The Philips sensor is a closed loop 0-10v sensor for use with Advance Mark 7 ballasts. **Occupancy Sensor:** Wattstopper occupancy sensor is a PIR sensor with additional hold-off daylight feature. Sensor cross section limited to 1.3" wide and 1.0" high.

**LIGHT ENGINE:** Available in 1 T8, and 1,2 or 3 T5 or T5HO lamp cross sections.

**BALLAST:** Electronic program start ballast <10% THD, 0.88 BF standard for T8 lamps. Electronic rapid-start ballasts <10% THD, 1.0 BF standard for T5 or T5HO lamps. **Optional adders:** emergency battery packs, dimming ballasts (controls by others). Requires low profile ballasts and battery packs. Ballast cross section limited to 1.3" wide and 1.0" high.

**MOUNTING:** (FA) 50" fully adjustable aircraft cable standard with safety stop. Contact factory for additional lengths up to 150". Mounting connects to fixture with factory-installed curved balancer, which allows for side-to-side fixture leveling and locks it into place. **Note:** Curved balancer assembly is 2.28" for standard or 2.8" with FM above top of fixture. **Optional (AC)** semi-adjustable aircraft cable (± 0.5") in lengths of 12", 15",

18", 21", 24", 27", 30", and 36".

**OPTIONAL FLEXIBLE MOUNTING BRACKET:**

The Flexible Mounting Bracket adjusts along the length of the luminaire to accommodate existing mounting points.

**SUPPORT CABLES:** Plated steel cable and hardware.

**FEED:** 18 gauge straight cord. 14 gauge feed cord used when fixture current exceeds 5 amps. **Optional Adders:** Coil Cord Feed.

**FINISHES:** Finelite Signal White standard. **Optional Adders:** 185 colors available from Tiger Drylac's RAL color chart.

**LENGTHS:** 4' and 8' section lengths can be combined to make longer runs. Contact factory for additional lengths.

**WEIGHT:** Fixture weight = 2.5 lb/ft.