

FIXTURE SPECIFICATIONS

INTENDED USE

The specification grade 9116 Architectural Landscape LED Low Voltage Stainless Steel In Ground Well Light features a durable, tempered lens and a silicone sealed gasket to protect from water, moisture, and insects. The 9116 is an ideal solution for landscape applications looking for quality and energy efficient lighting.

FEATURES

- Construction:** Die-cast aluminum face plate
- Connection:** 20" 18AWG Lead Wire
- Voltage:** 12V AC/DC
- Wattage:** 2 Watts
- Lumens:** 160lms

- CRI:** 85+
 - Color Temperature:** 3000K
 - Beam Spread:** 25°
 - Warranty:** 3 Years Carefree for Parts & Components (Labor Not Included)
 - Listings:** cETLus, Wet Location IP65
 - Operating Temperature:** -4 ~ 122°F (-20 ~ 50°C)
 - Ambient Temperature:** -4 ~ 176°F (-20 ~ 80°C)
- Dimmable*

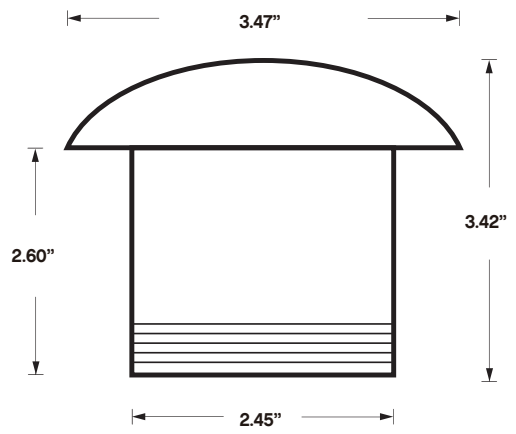

ORDERING INFORMATION Example: (9116-WH)

Model	Finish
9116	WH White BK Black