

Rectilinear LED bi-directional light fixture

Project: \_\_\_\_\_ Type: \_\_\_\_\_

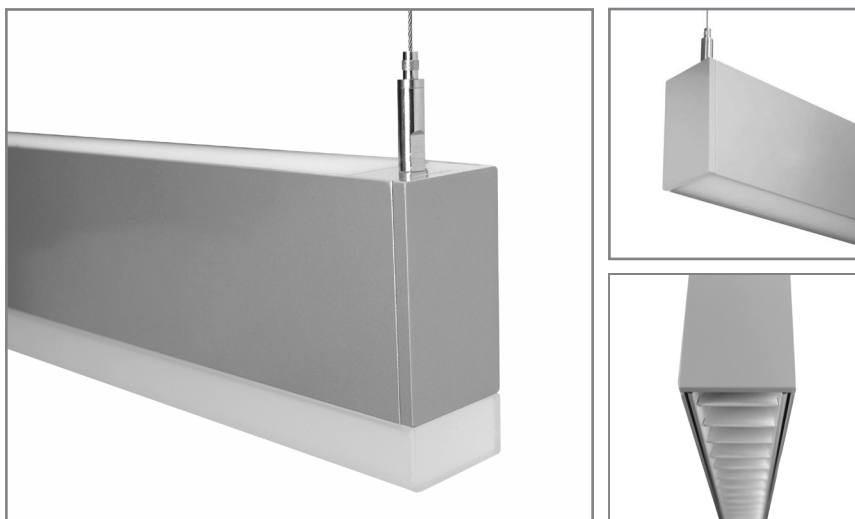

## FEATURES

The Bodhi series BSS255 a rectilinear bi-directional LED luminaire for general lighting applications. The 2" wide by 3-1/2" high extruded aluminum housing is offered for wall or cable suspended mounting. The two LED sources can be configured independently for both switching and

## SPECIFICATIONS

Fixture constructed of extruded aluminum, frosted extruded acrylic lenses and machined aluminum end caps

Model variations offered for wall mount and cable suspended applications

Standard finishes as shown below

Available in nominal lengths of 2'-8' single fixtures and continuous runs

Basic continuous run fixtures provided with 18 ga. wiring harness for 6 Amp maximum load (consult factory for runs requiring multiple circuits, sensor integration, etc.)

Standard integral 120-277V driver offered with 0-10V dimming or non-dim (other dimming driver options available)

Integral 120-277V emergency battery backup available for 6' or 8' nominal, single circuit non-dim or 0-10V (consult factory for all other lengths/drivers)

Standard light outputs range from 470 - 650lumens per foot for the direct source and 460 - 740 lumens per foot for the indirect source

LEDs available in 2700K, 3000K, 3500K and 4000K, within a 3 step MacAdam ellipse, all with 90+ CRI typical

Life: 50,000 hours L<sub>70</sub>

Limited five year warranty

## SECTION

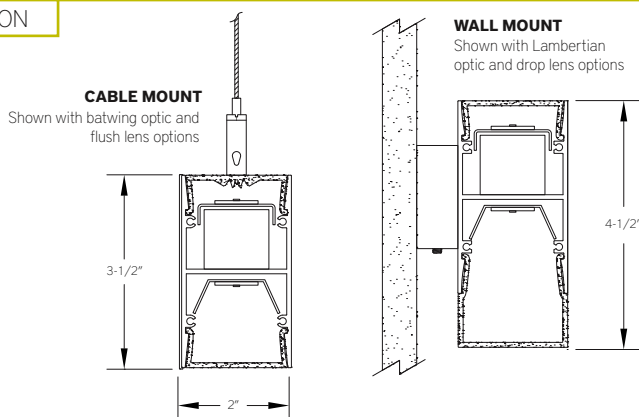

GET A QUOTE >

## PERFORMANCE

Note: All data reflects fixtures with 3500K LEDs

NOMINAL LENGTH	OPTIC CONFIGURATION	OUTPUT	LUMENS/ft.	WATTS/ft.	LUMINAIRE LUMENS	EFFICACY (LPW)
4'	Indirect - Lambertian	L: low	465	5	1738	93
		R: regular	600	7.2	2257	84
	Indirect - batwing	L: low	570	5.7	2112	100
		R: regular	740	7.9	2743	94

OPTIC CONFIGURATION	OUTPUT	LUMENS/ft.	WATTS/ft.	LUMINAIRE LUMENS	EFFICACY (LPW)
Direct - flush lens	L: low	470	5	1755	94
	R: regular	610	7.2	2279	85
Direct - drop lens, solid end	L: low	500	5	1850	99
	R: regular	650	7.2	2402	90



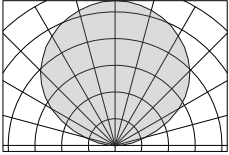
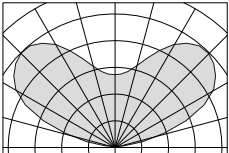

## BSS255 -

<b>NOMINAL FIXTURE LENGTH*</b> 2: 22-5/8" 3: 33-5/8" 4: 44-5/8" 5: 55-5/8" 6: 66-5/8" 7: 77-5/8" 8: 88-5/8"	<b>DRIVER</b> <b>ND: non-dimming</b> <b>[Dimming]</b> D: 0-10V, 1% HES: Lutron EcoSystem, soft-on/fade-to-black, 1% H2: Lutron Hi-lume 2-wire forward phase, 1%, (120V ONLY) E5: Lutron EcoSystem 5-Series, 5% EL: eldoLED ECOdrive 0-10V, 1%	<b>INDIRECT LIGHT OUTPUT</b> (lumens per foot) L: low- 465 (w/optic option 1) R: regular- 600 (w/optic option 1) CF: consult factory for custom output	<b>INDIRECT OPTIC</b> 1: general Lambertian distribution 2: batwing distribution	<b>MOUNT</b> C4: cable mount 4' cable length C8: cable mount 8' cable length WM: wall mount CF: consult factory for custom mounting	<b>OPTIONS</b> ED: emergency driver (6' or 8' SINGLE CIRCUIT, non-dim or 0-10V only)	<b>FINISH</b> AW: architectural white (semi-matte) WH: white (semi-gloss) BL: black (semi-matte) MB: matte black ESS: environmental satin silver BZ: bronze PR: primer CF: consult factory for custom finish
<b>CORRELATED COLOR TEMPERATURE</b> 27: 2700K-90+ CRI 30: 3000K-90+ CRI 35: 3500K-90+ CRI 40: 4000K-90+ CRI	* Actual dimension dependent on run configuration	<b>CIRCUIT</b> 1: single circuit 2: two circuit (4' nom. length and longer)	<b>DIRECT LIGHT OUTPUT</b> (lumens per foot) L: low- 500 (w/optic option B) R: regular- 650 (w/optic option B) CF: consult factory for custom output	<b>DIRECT OPTIC</b> A: flush lens B: drop lens - solid end C: drop lens - illuminated end D: louver (4' and 8' only)	<b>RUN CONFIGURATION</b> SN: single ST: starter AD: adder TR: terminator	SA: satin anodize (may require additional lead time)

## INDIRECT OPTIC OPTION

ORDERING CODE	DESCRIPTION	SPECIFICATIONS
	1 Lambertian distribution	Frosted extruded acrylic lens for general Lambertian distribution
	2 Batwing distribution	Clear extruded acrylic with wide distribution optic features

## DIRECT OPTIC OPTION

ORDERING CODE	DESCRIPTION	SPECIFICATIONS
	A FLUSH LENS	Flush frosted acrylic extrusion
	B DROP LENS - SOLID END	1" H frosted acrylic extrusion with full height aluminum end cap
	C DROP LENS - ILLUMINATED END	1" H frosted acrylic extrusion with matching acrylic end cap
	D LOUVER	Parabolic louver with 5/8" blades at 1" spacing, formed from diffuse, high reflectance aluminum and supplied with light diffusion film. Available for 4' and 8' nominal length fixtures.

## MOUNTING

	ORDERING CODE	DESCRIPTION
	C4 and C8	<p>CABLE MOUNT</p> <p>Mounting option includes:</p> <ul style="list-style-type: none"> <li>• Ø 1/16" x 48" (C4) or 96" (C8) aircraft cables</li> <li>• 60" (C4) or 108" (C8) power cable in coordinating finish</li> <li>• Bracket bars</li> <li>• Ø 5" white canopies</li> <li>• Ceiling couplers</li> <li>• Side exit cable grippers</li> </ul> <p><b>NOTE: WHEN DUAL CIRCUIT OPTION IS USED, TWO POWER CABLES ARE REQUIRED</b></p>
	WM	<p>WALL MOUNT</p> <p>Mounting option includes:</p> <ul style="list-style-type: none"> <li>• 1-7/8"H x 2-1/2"W aluminum bracket projects the fixture housing 3/4" from the wall surface</li> </ul>

## OPTIONS

ORDERING CODE	DESCRIPTION	SPECIFICATIONS
ED	EMERGENCY LED DRIVER	<ul style="list-style-type: none"> <li>• Universal 120-277V input voltage emergency driver delivers initial minimum power of 10W for 90 minutes</li> <li>• Available for SINGLE CIRCUIT <b>6' or 8'</b> nominal length non-dim or 0-10V fixture and direct light source only (consult factory for all other lengths/drivers)</li> </ul>