

The Reflex® Series provides the designer with unmatched versatility. Designed for installation in ceilings or walls, this fixture provides substantial indirect lighting, as well as superb wall wash capability. Reflex® can also be installed at aisle level for illumination of corridors and hallways.

The clean lines of the Reflex® design are complimented by a variety of architectural grade trims and tempered glass lenses. One piece seamless reflectors are available in a stylish array of architectural finishes. Engineered to fit neatly between the studs of new construction or renovations, the simplicity and elegance of our Reflex® design make this fixture an ideal choice for retail, hospitality or corporate applications.

Subtle

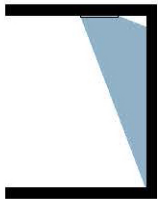

WALL WASH
INDIRECT



Simple



CEILING MOUNT
INDIRECT

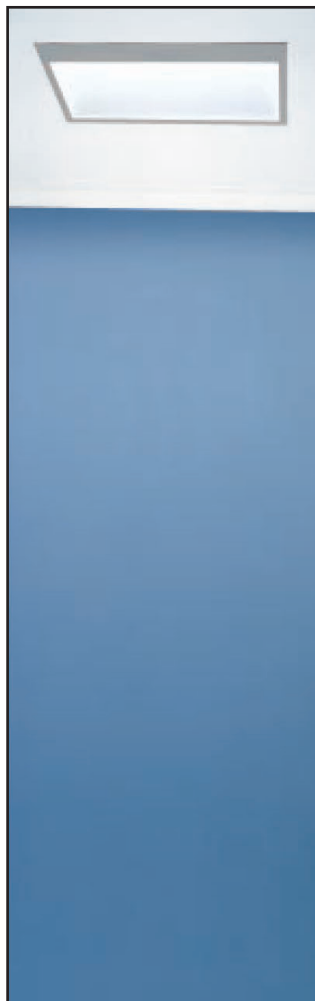

Stylish

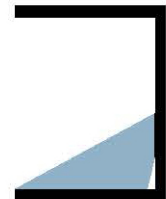

AISLE MOUNT
DIRECT



*(not allowable with
RX1351 or RX1352)*

RX 1341-LED

High Power LED Reflex®

REFLEX® CEILING, WALL OR AISLE MOUNTED RECESSED FIXTURE

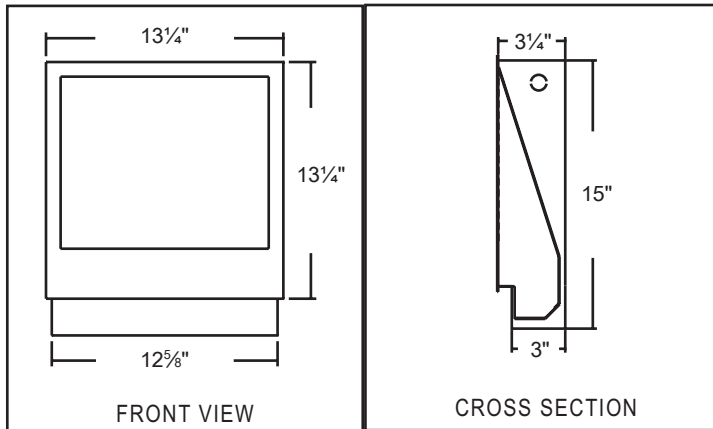

PROJECT

TYPE

CATALOG#



RX1341-LED MWR SHOWN WITH RX1341A PDS SA TRIM

MOUNTING OPTIONS

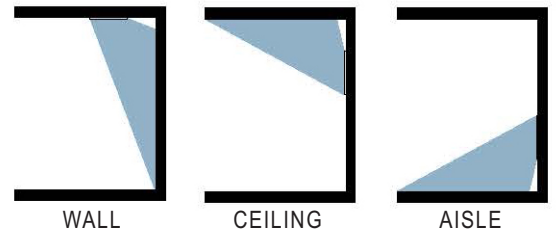

- ADA Compliant for Wall, Ceiling or Aisle
- RX1341-LED Housing Constructed of White Steel
- Internal Solite™ Tempered Glass Lens included
- Lumen Options
 - 2700k (2277 Initial Lumens, 18 Watts, 126 L/W)
 - 3000k (2277 Initial Lumens, 18 Watts, 126 L/W)
 - 3500k (2277 Initial Lumens, 18 Watts, 126 L/W)
- CRI Options
 - 80+
 - 90+
- Voltage Options
 - 120 Volts
 - 277 Volts
- Dimming with standard Low Voltage Phased PWM, 0-10V
Dimmer controls by others
- Standard Reflector Options:
 - High Reflectance Matte White
 - High Reflectance Gloss White
 - Satin Anodized Aluminum
 - Stainless Steel
 - Satin Horizontal Ribbed
- RX1341A Trim 13 1/4"W x 13 1/4"H
Order Housing and Trim Accessory Separately
- UL and CUL Listed Damp Location (non IC only)

Ordering Format *choose one from each category*

SERIES	KELVIN	CRI	VOLTAGE	REFLECTOR	TRIM ACCESSORY
RX 1341-LED LED Reflex®	27 2700K	80 80+	1 120 Volt	MWR High Reflectance Matte White	ORDER RX1341A TRIM
	30 3000K	90 90+	2 277 Volt	GWR High Reflectance Gloss White	See Standard and Dimensional Trim Options
	35 3500K			SAR Satin Anodized Aluminum	
				SSR Stainless Steel	
				SHR Satin Horizontal Ribbed	



Reflex® Trim Accessory

TRIM ACCESSORY FOR USE WITH RX1341-LED REFLEX® FIXTURES

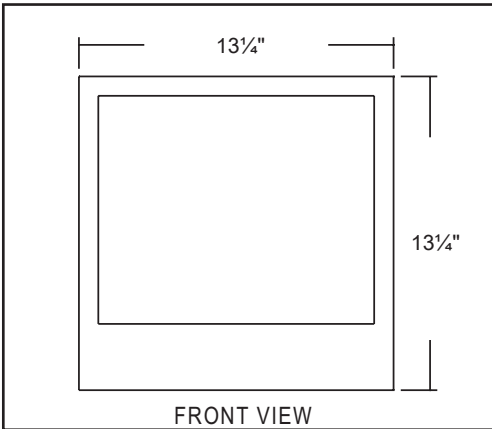

- RX1341A Constructed of White CRS, Steel or Stainless Steel
- Trim Accessory Options:

- Frosted Glass Shield
- Perforated Diffuser Shield
- Full Panel Solite™ Glass
- Dimensional Metal Trim Solid
- Finish Options
 - Satin Aluminum
 - White Powder Coat
 - Black Powder Coat
 - Titanium Powder Coat
 - Stainless Steel (DTS only)
 - Custom Colors are available, please consult factory.
- Tempered Panel Glass Accessories
(available for placement behind PDS and DTS trims)

PROJECT

TYPE

CATALOG#

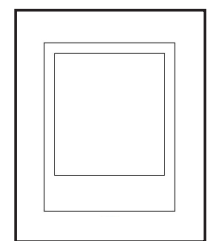
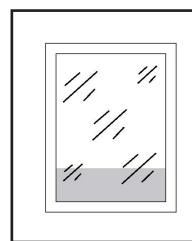
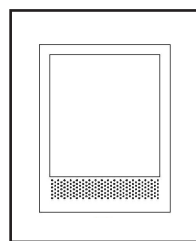
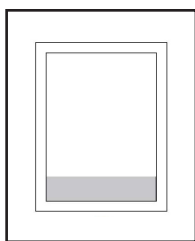

Ordering Format *choose one from each category*

SERIES

RX1341A
RX1341
Reflex® Trim
Accessory

TRIM ACCESSORY

STANDARD TRIM
FGS 2 1/4" Frosted Glass
PDS Perforated Diffuser with Frosted Glass Insert
PGS Full Solite™ Panel with 3 1/2" Frost

FINISH

STANDARD TRIM
SA Satin Aluminum
WP White Powder Coat
BP Black Powder Coat
TT Titanium Powder Coat

DIMENSIONAL TRIM

DTS Dimensional Trim Solid



Satin White Black Titanium Stainless

DIMENSIONAL TRIM

SA Satin Aluminum
WP White Powder Coat
BP Black Powder Coat
TT Titanium Powder Coat
SS Stainless Steel



REFLEX® REFLECTOR OPTIONS



MWR
 MATTE WHITE



GWR
 GLOSS WHITE



SAR
 SATIN ANODIZED
 ALUMINUM



SSR
 STAINLESS STEEL
*(not available with RX1351 or
 RX1352)*



SHR
 SATIN HORIZONTAL
 RIBBED

REFLEX® TRIM ACCESSORY OPTIONS



PGS
 PANEL GLASS
 TITANIUM SHOWN

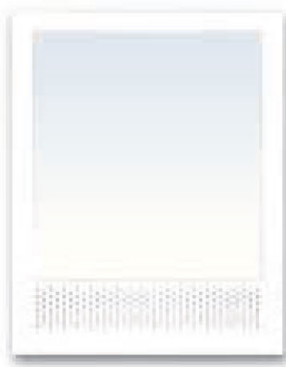

PDS
 PERFORATED DIFFUSER
 WHITE SHOWN



FGS
 FROSTED GLASS
 SATIN SHOWN



DTS
 DIMENSIONAL TRIM SOLID
 TITANIUM SHOWN
RX1351 and RX1352 are available with DTS Trim only

REFLEX® CUSTOM FIXTURES AND MODIFICATIONS

If you have applications which dictate modifications to our standard Reflex fixtures, please contact our sales dept. In addition to modifications, Belfer has complete custom capabilities for your project. Our team of customer service and technical specialists are at your disposal to answer questions and offer advice about application, lamp placement and lighting objectives.

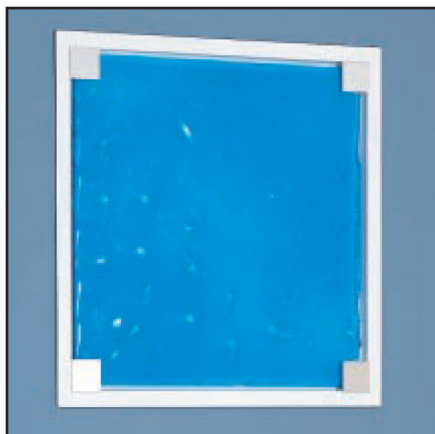

REFLEX® CEILING, WALL OR AISLE
MOUNTED RECESSED FIXTURE



**CLEAN ARCHITECTURAL
DETAILING, ADA COMPLIANT**



**TEMPERED GLASS
ACCESSORIES**

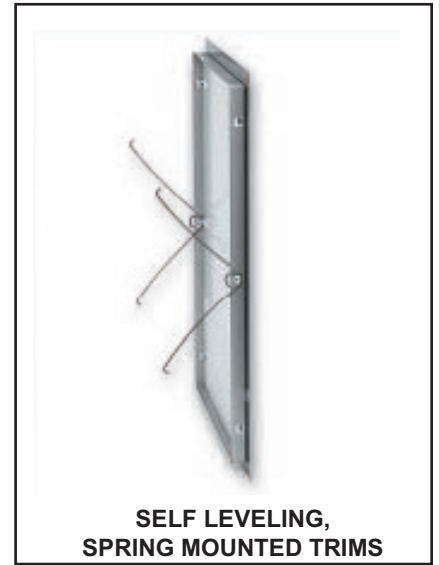

**SELF LEVELING,
SPRING MOUNTED TRIMS**



CUSTOM SILKSCREENING



SEAMLESS CORNERS

A variety of custom glass panels are available such as dichroic, colored, custom etched and designer panels, such as Solite™ Panel Glass, Clear Glass Panel, Skytex Horizontal Panel Glass, Skytex Vertical Panel Glass.

Please consult factory to discuss your specific requirements.

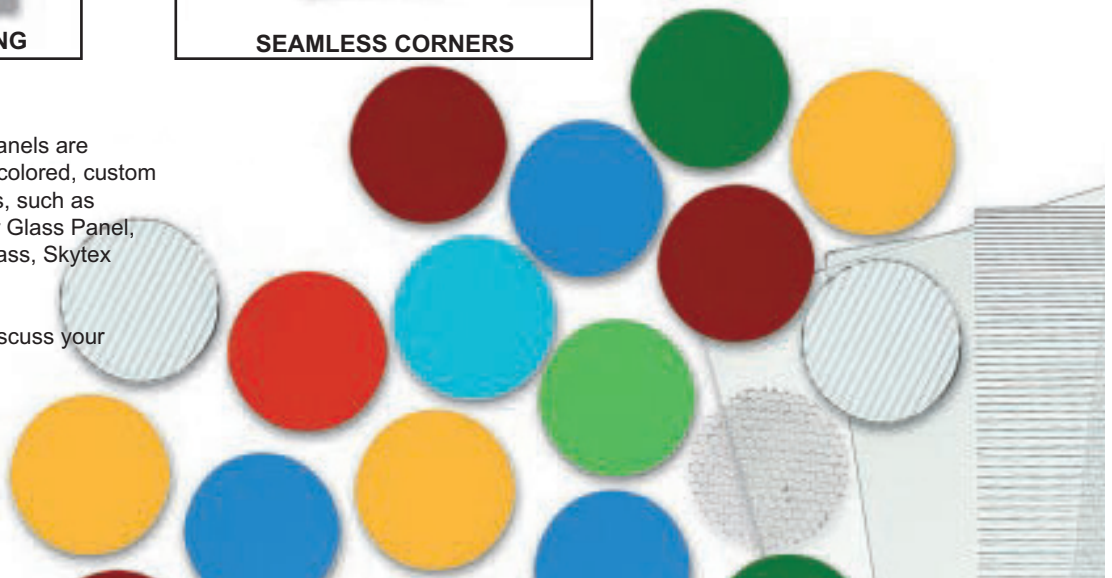

REFLEX® SIMPLE 3 STEP ASSEMBLY



The Reflex-LED integrated, adjustable mounting frame installs in 3 easy steps. The backbox is mounted in the wall and adjusted level. Secondly the Reflex® reflector slides seamlessly into the back box to enhance the LED output. The self leveling, spring mounted trim easily attached to the fixture to complete the look with clean architectural detailing.



RX1320-LED and RX1341-LED
SHOWN



RX1351-LED and RX1352-LED
SHOWN