

The Reflex® Series provides the designer with unmatched versatility. Designed for installation in ceilings or walls, this fixture provides substantial indirect lighting, as well as superb wall wash capability. Reflex® can also be installed at aisle level for illumination of corridors and hallways.

The clean lines of the Reflex® design are complimented by a variety of architectural grade trims and tempered glass lenses. One piece seamless reflectors are available in a stylish array of architectural finishes. Engineered to fit neatly between the studs of new construction or renovations, the simplicity and elegance of our Reflex® design make this fixture an ideal choice for retail, hospitality or corporate applications.

Subtle



WALL WASH
INDIRECT



Simple



CEILING MOUNT
INDIRECT

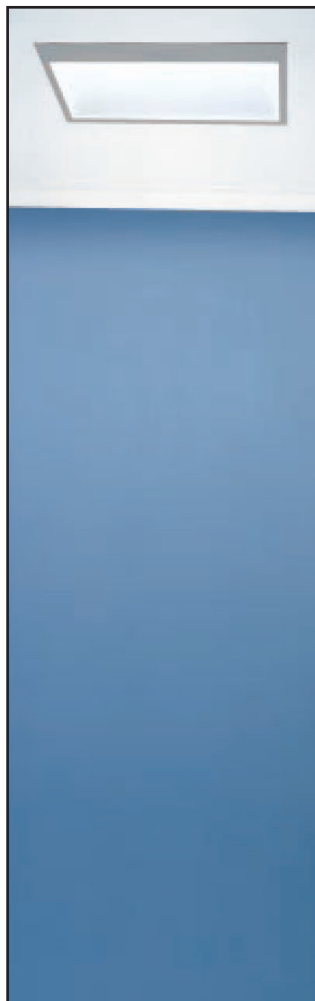

Stylish

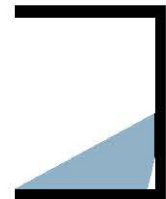

AISLE MOUNT
DIRECT



*(not allowable with
RX1351 or RX1352)*

RX 1351-LED High Power LED Reflex®

REFLEX® CEILING OR WALL
MOUNTED RECESSED FIXTURE

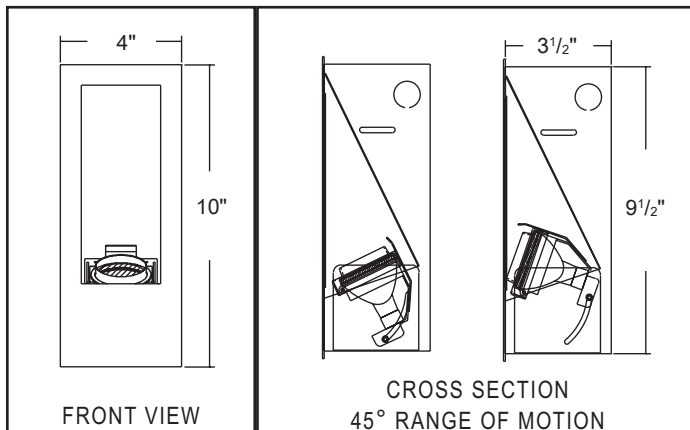

PROJECT

TYPE

CATALOG#



RX1351-LED MWR
SHOWN WITH RX1351A
DTS WH TRIM

- ADA Compliant for Wall and Ceiling
- Individual Locking Mechanisms ensure consistent lighting presentation
- 45° Range of Motion
- RX1351-LED Housing Constructed of White Steel
- For use with MR16 LED Replacement Lamps by others
- Voltage Options
 - 120 Volts
 - 277 Volts
- Dimming with standard Electronic Low Voltage (ELV) Dimmer controls by others
- Standard Reflector Options:
 - High Reflectance Matte White
 - High Reflectance Gloss White
 - Satin Anodized Aluminum
 - Stainless Steel
 - Satin Horizontal Ribbed
- RX1351A Trim 4"W x 10"H
Order Housing and Trim Accessory Separately
- UL and CUL Listed Damp Location (non IC only)

MOUNTING OPTIONS

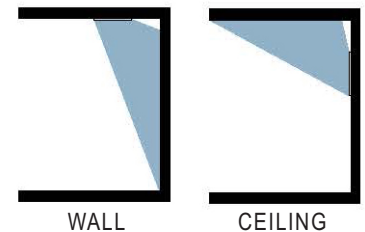

WALL

CEILING

Ordering Format *choose one from each category*

SERIES	VOLTAGE	REFLECTOR	TRIM ACCESSORY
RX 1351-LED LED Reflex®	1 120 Volt	MWR High Reflectance Matte White	ORDER RX1351A TRIM
	2 277 Volt	GWR High Reflectance Gloss White	See Standard and Dimensional Trim Options
		SAR Satin Anodized Aluminum	
		SHR Satin Horizontal Ribbed	



Reflex® Trim Accessory

TRIM ACCESSORY FOR USE WITH RX1351-LED REFLEX® FIXTURES

PROJECT

TYPE

CATALOG#

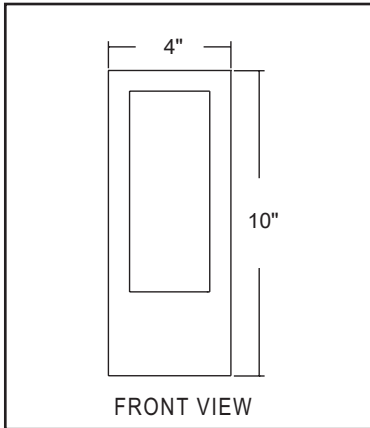

- RX1351A Constructed of White CRS, Steel or Stainless Steel
- Trim Accessory Options:
 - Dimensional Metal Trim Solid
- Finish Options
 - Satin Aluminum
 - White Powder Coat
 - Black Powder Coat
 - Titanium Powder Coat
 - Stainless Steel
 - Custom Colors are available, please consult factory.

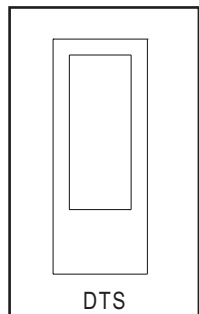

Ordering Format *choose one from each category*

SERIES
RX1351A
RX1351
Reflex® Trim
Accessory

TRIM ACCESSORY
DIMENSIONAL TRIM
DTS Dimensional Trim Solid

FINISH
DIMENSIONAL TRIM
SA Satin Aluminum
WP White Powder Coat
BP Black Powder Coat
TT Titanium Powder Coat
SS Stainless Steel



REFLEX® REFLECTOR OPTIONS



MWR
MATTE WHITE



GWR
GLOSS WHITE



SAR
SATIN ANODIZED
ALUMINUM



SSR
STAINLESS STEEL
*(not available with RX1351 or
RX1352)*



SHR
SATIN HORIZONTAL
RIBBED

REFLEX® TRIM ACCESSORY OPTIONS



PGS
PANEL GLASS
TITANIUM SHOWN



PDS
PERFORATED DIFFUSER
WHITE SHOWN



FGS
FROSTED GLASS
SATIN SHOWN



DTS
DIMENSIONAL TRIM SOLID
TITANIUM SHOWN
RX1351 and RX1352 are available with DTS Trim only

REFLEX® CUSTOM FIXTURES AND MODIFICATIONS

If you have applications which dictate modifications to our standard Reflex fixtures, please contact our sales dept. In addition to modifications, Belfer has complete custom capabilities for your project. Our team of customer service and technical specialists are at your disposal to answer questions and offer advice about application, lamp placement and lighting objectives.

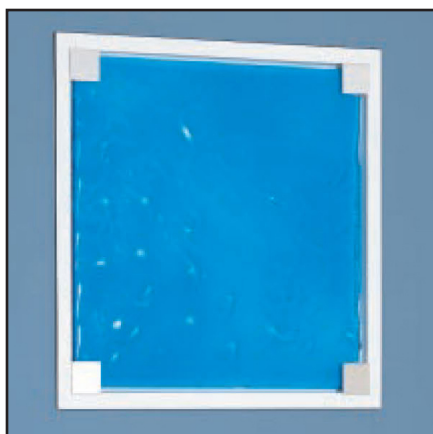

REFLEX® CEILING, WALL OR AISLE
MOUNTED RECESSED FIXTURE



**CLEAN ARCHITECTURAL
DETAILING, ADA COMPLIANT**



**TEMPERED GLASS
ACCESSORIES**

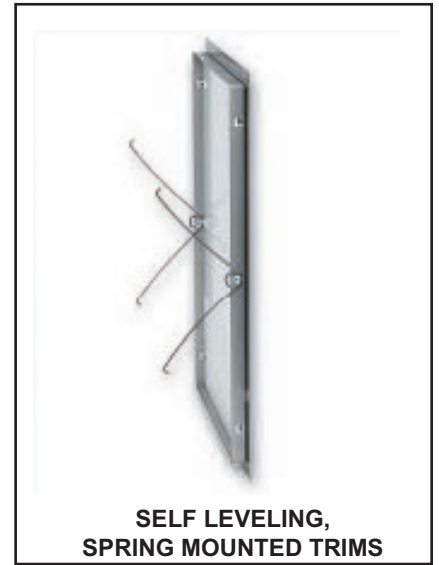

**SELF LEVELING,
SPRING MOUNTED TRIMS**



CUSTOM SILKSCREENING



SEAMLESS CORNERS

A variety of custom glass panels are available such as dichroic, colored, custom etched and designer panels, such as Solite™ Panel Glass, Clear Glass Panel, Skytex Horizontal Panel Glass, Skytex Vertical Panel Glass.

Please consult factory to discuss your specific requirements.

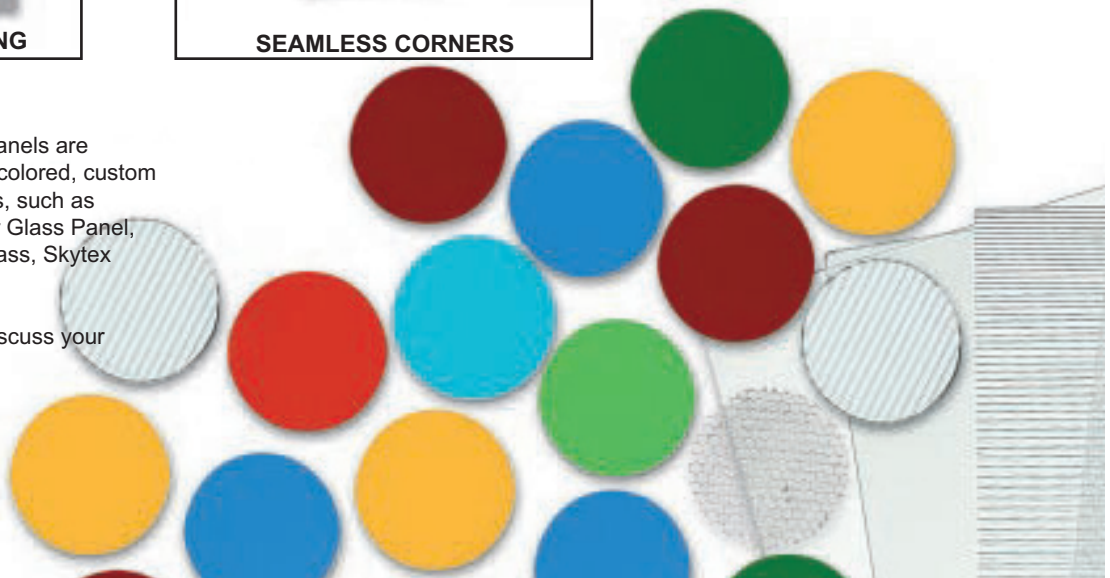

REFLEX® SIMPLE 3 STEP ASSEMBLY



The Reflex-LED integrated, adjustable mounting frame installs in 3 easy steps. The backbox is mounted in the wall and adjusted level. Secondly the Reflex® reflector slides seamlessly into the back box to enhance the LED output. The self leveling, spring mounted trim easily attached to the fixture to complete the look with clean architectural detailing.



RX1320-LED and RX1341-LED
SHOWN



RX1351-LED and RX1352-LED
SHOWN