

# BUBBLE RGB

WEB PIN™ 260

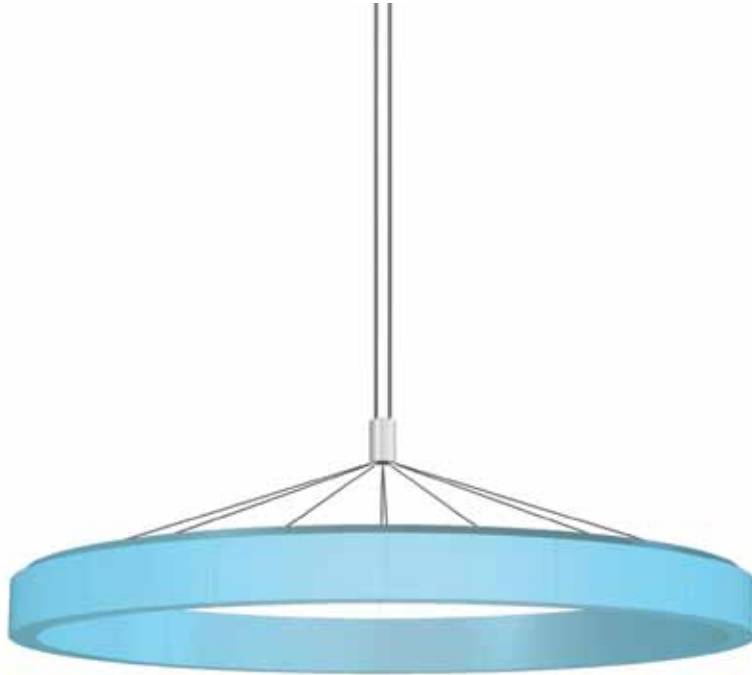

## GENERAL SPECIFICATION

**Housing:** Round metal frame consisting of modules combined together for electrical and mechanical connection. Bubbles supplied in the following diameters: 600mm (23.6") 1000mm (39.4"), 1800mm (70.9") and 2800mm (110.0").

**Diffusers:** Injection molded, UV stabilized, opal polycarbonate. Diffusers are sectional with subtle but visible seams. Bubble 600, 3 diffusers; Bubble 1000, 3 diffusers; Bubble 1800, 8 diffusers and Bubble 2800, 16 diffusers.

**Drivers/power supplies:** Luminaires supplied with electronic drivers/DMX interfaces, 120/277V.

**Power cables:** Luminaires supplied with 7.8m/20' of cable. Cables can be extended to a maximum overall distance of 20m/64'. Custom cable lengths can be supplied to special order.

**RGB control:** Luminaires require a DMX controller by others.

**Mechanical:** Luminaires mount directly over a junction box.

**Finish:** White RAL 9003.

**Approvals:** ETL.

DIAMETER: 600/1000/1800

**A SPECIFY LAMP/LUMINAIRE TYPE**

Code:	Lamp:	Diameter (A):	Diameter (B):	Depth (D):	Weight:
D15SD163AE	45W LED RGB	600mm/23.6"	440mm/17.3"	191mm/7.5"	8.1kg/17.9lbs
D15SD164AE	80W LED RGB	1000mm/39.4"	800mm/31.5"	241mm/9.5"	16.1kg/35.5lbs
D15SD165AE	156W LED RGB	1800mm/70.9"	1600mm/63.0"	241mm/9.5"	33.0kg/72.8lbs

**B SPECIFY POWER SUPPLY AND ACCESSORIES**

**Bubble Emotion integral power supply including DMX interface (complete with larger diameter canopy)**

- BCDMX6/IN** Canopy with power supply and DMX interface for Bubble 600
- BCDMX10/IN** Canopy with power supply and DMX interface for Bubble 1000
- BCDMX18/IN** Canopy with power supply and DMX interface for Bubble 1800

**Bubble Emotion remote power supply including DMX interface (specify mounting canopy from bubble accessories as a separate line item)**

- BCDMX6/R** Remote power supply with DMX interface for Bubble 600
- BCDMX10/R** Remote power supply with DMX interface for Bubble 1000
- BCDMX18/R** Remote power supply with DMX interface for Bubble 1800

**Bubble Emotion accessories (for luminaires with remote power supplies only)**

- MEC1745AE** Ceiling canopy for installation to load bearing ceilings (max 32kg/70lbs) for Bubble 600 and Bubble 1000.
- MEC2112AE** Ceiling canopy for installation to load bearing ceilings (max 100kg/220lbs) for Bubble 1800.
- MEC1823AE** Ceiling canopy for installation into false ceilings or similar (cables are anchored to the load bearing ceiling).

**Surface mounting kits for remote power supply.**

- BCLED6/SK** Surface mounting kit for Bubble 600
- BCLED10/SK** Surface mounting kit for Bubble 1000
- BCLED18/SK** Surface mounting kit for Bubble 1800

**Notes: DMX CONTROLLERS BY OTHERS**

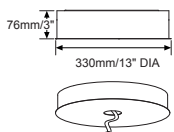

**BCDMX6/IN**  
**BCDMX10/IN**

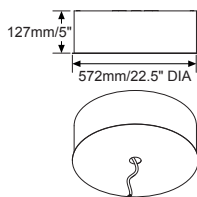

**BCDMX18/IN**

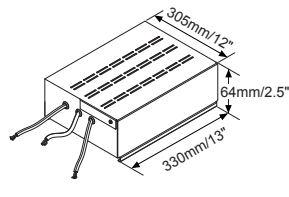

**BCDMX6/R**  
**BCDMX10/R**

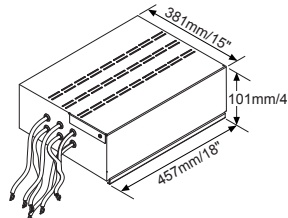

**BCDMX18/R**

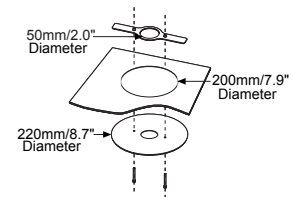

**MEC1823AE**

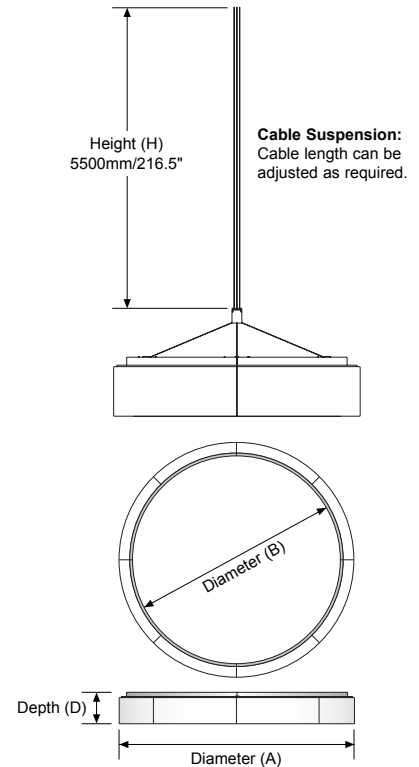

## DIAMETER: 2800

### A SPECIFY LAMP/LUMINAIRE TYPE

**LOW PROFILE PENDANT** Luminaire complete with 8 suspension cables connected to the central joint for ceiling mounting.

**Code:** **BCBE28LPRC** **Lamp:** 264W LED RGB, remote power supply with DMX interface

**Weight:** 63kg/138.9lb

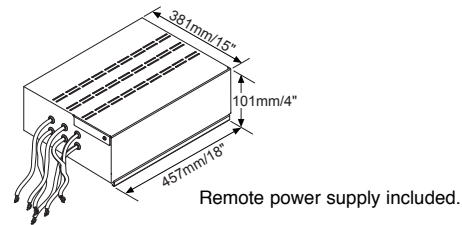
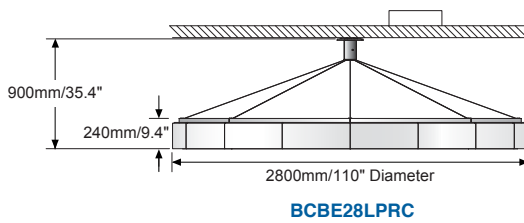

**ADJUSTABLE PENDANT** Luminaire complete with 8 cables connected to the central joint and 4 adjustable cables for ceiling mounting.

**Code:** **BCBE28PIC** **Lamp:** 264W LED RGB, integral power supply with DMX interface  
**BCBE28PRC** 264W LED RGB, remote power supply with DMX interface

**Weight:** 75kg/165.3lb  
 67kg/147.7lb

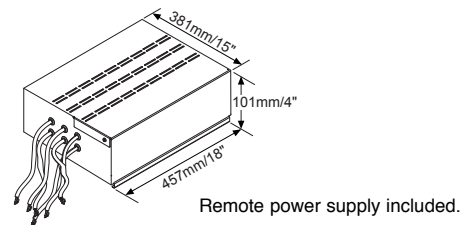
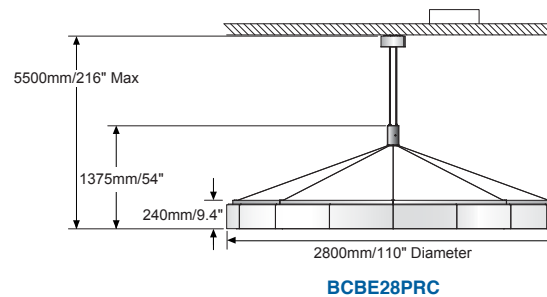
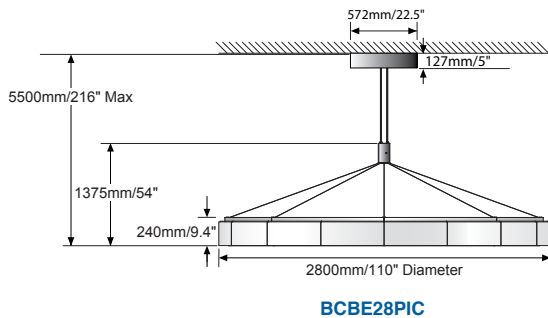

## DIAMETER: 2800

**CEILING MOUNTED** Luminaire complete with 8 suspension cables L=2000mm/79".

Code:	Lamp:	Weight:
<b>BCBE28CMIC</b>	264W LED RGB, integral power supply with DMX interface	74kg/163.1lb
<b>BCBE28CMRC</b>	264W LED RGB, remote power supply with DMX interface	66kg/145.5lb

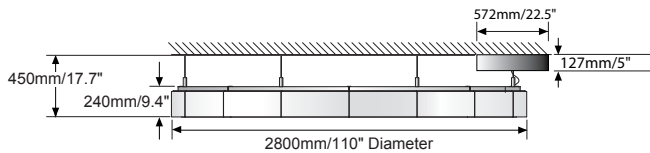

**BCBE28CMIC**

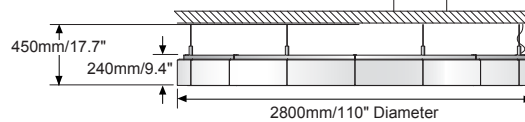

**BCBE28CMRC**

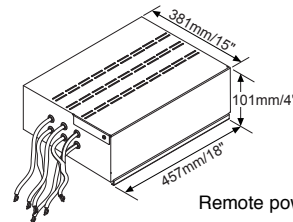

Remote power supply included.

### **B** SPECIFY ACCESSORIES (REQUIRED)

**150A031VE** Umbrella tool for assembly/installation of Bubble 2800. Retains structural integrity during the installation process (only one required).

