

SPECIFICATION SHEET

JOB NAME: _____
 LOCATION: _____
 QUOTE/REF#: _____



LSP50RGBW is a color changing flexible LED strip that provides a full spectrum of color options using red, green blue and white LED technology. The countless color mixing possibilities make RGB LEDs a diverse choice for even the most critical in lighting solutions and applications. It can be easily installed onto most surfaces with its attached double-sided mounting tape.

FEATURES

- Superior Color Rendering Index (CRI)
- Field cuttable
- Up to 25 ft. of continuous linear light
- Architectural grade LED lighting
- Suitable for accent or ambient lighting

SPECIFICATIONS

INPUT VOLTAGE	24V DC constant voltage
POWER CONSUMPTION	4.4W per ft.
LUMEN OUTPUT	287 Lumens per ft.
NO. OF LEDs	18 LEDs per ft.
BEAM ANGLE	120°
CRI	90*
DIMMING	Through RGB controller
MAXIMUM RUN LENGTH	25 ft.
FIELD CUTTABLE	every 8"
IP RATING	IP45 (indoor/dry), IP65 (outdoor/wet)
LUMEN MAINTENANCE	50,000 Hrs
CERTIFICATIONS	UL Listed, TITLE 24
DIMENSIONS	Width x Depth: 0.47" x 0.15"

RGB COLOR SPECTRUM

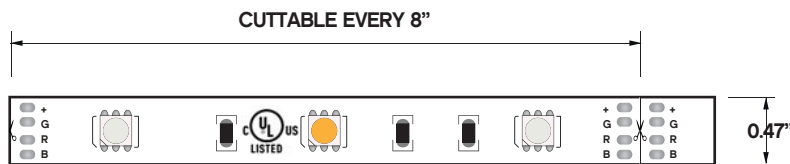

ORDERING GUIDE

MODEL	COLOR TEMPERATURE	LENGTH	VOLTAGE
LSP50 - Indoor LSPW50- Outdoor	RGBW27K - RGB + 2700K RGBW30K - RGB + 3000K RGBW50K - RGB + 5000K	16 - 16.4 FT. 100 - 100 FT. PF - PER FT. (12")	24 - 24V DC

COMPATIBLE CHANNELS
*Custom Finish Available

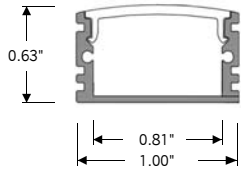

ALU-DS100 | SURFACE MOUNT

LENGTHS	39 ³ / ₈ " and 78 ⁷ / ₈ "
LENS	Clear & Frosted
FINISH	Anodized Silver

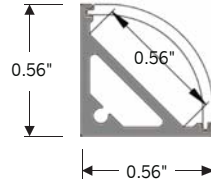

ALP-50C | SURFACE / CORNER MOUNT

LENGTHS	49.25" and 98.5"
LENS	Frosted
FINISH	Anodized Silver

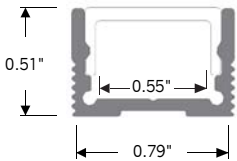

ALP-70 | SURFACE MOUNT

LENGTHS	49.25" and 98.5"
LENS	Frosted
FINISH	Anodized Silver

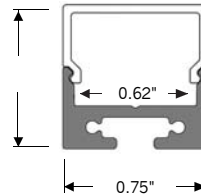

ALP-80 | SURFACE OR SUSPENDED MOUNT

LENGTHS	49.25 and 98.5"
LENS	Frosted
FINISH	Anodized Silver

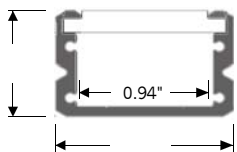

ALP-90 | SURFACE MOUNT

LENGTHS	48" and 96"
LENS	Frosted
FINISH	Anodized Silver & Black

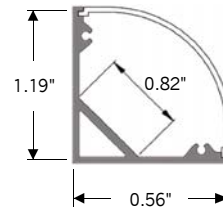

ALP-100C | SURFACE MOUNT

LENGTHS	49.25" and 98.5"
LENS	Frosted
FINISH	Anodized Silver

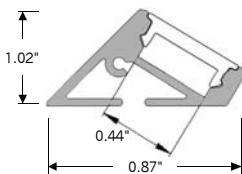

ALP-110 | SURFACE MOUNT

LENGTHS	49.25 and 98.5"
LENS	Frosted
FINISH	Anodized Silver

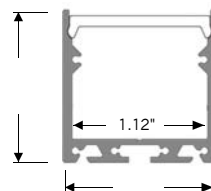

ALP-140 | SURFACE OR SUSPENDED MOUNT

LENGTHS	49.25" and 98.5"
LENS	Frosted
FINISH	Anodized Silver



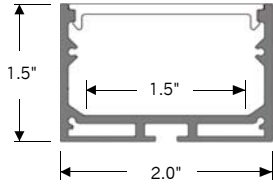

ALP-160 | SURFACE OR SUSPENDED MOUNT

LENGTHS	49.25" and 98.5"
LENS	Frosted
FINISH	Anodized Silver

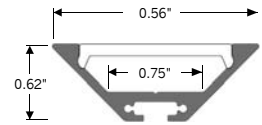

ALP-190 | SURFACE OR SUSPENDED MOUNT

LENGTHS	49.25" and 98.5"
LENS	Frosted
FINISH	Anodized Silver

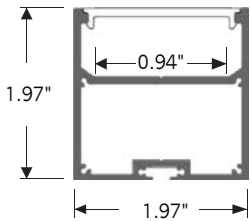

ALP-200 | SURFACE OR SUSPENDED MOUNT

LENGTHS	49.25" and 98.5"
LENS	Frosted
FINISH	Anodized Silver

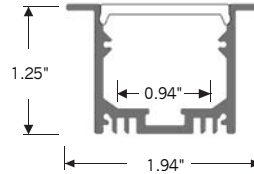

ALP-200R | RECESSED MOUNT

LENGTHS	49.25" and 98.5"
LENS	Frosted
FINISH	Anodized Silver

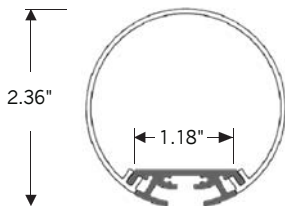

ALP-245 | SUSPENDED MOUNT

LENGTHS	49.25 and 98.5"
LENS	Frosted
FINISH	Anodized Silver

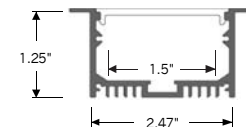

ALP-250R | RECESSED MOUNT

LENGTHS	49.25" and 98.5"
LENS	Frosted
FINISH	Anodized Silver

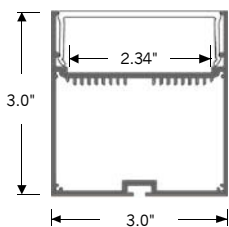

ALP-300 | SURFACE OR SUSPENDED MOUNT

LENGTHS	49.25" and 98.5"
LENS	Frosted
FINISH	Anodized Silver

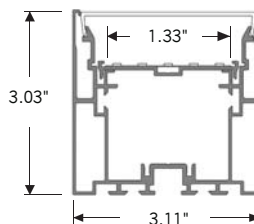

ALP-310N | SURFACE OR SUSPENDED MOUNT

LENGTHS	48" and 96"
LENS	Frosted
FINISH	Anodized Silver



LSP-50RGB+W 4.4W Color Changing + White LED Strip

COMPATIBLE RGB CONTROLLERS

WALL CONTROLLERS

RGB-CT600

INPUT VOLTAGE	5V DC, 1A
OUTPUT SIGNAL	RF 2.4GHz + DMX512
CONTROL	4 ZONES
WORKING TEMP	-30°C ~ 55°C
WEIGHT (gross)	370g

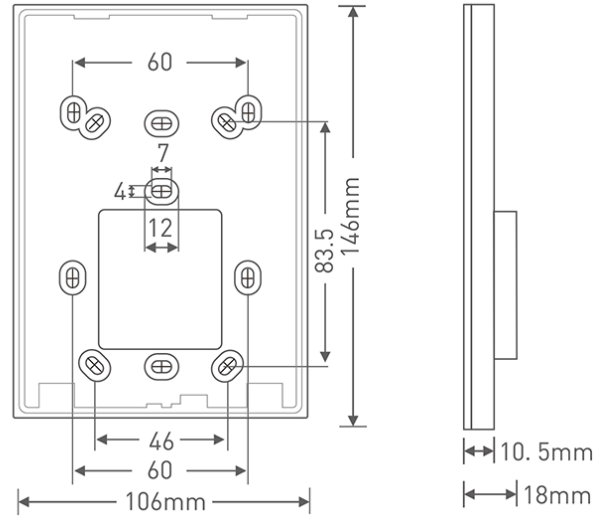

RGB-SDE3

INPUT POWER	6V DC 0.6A
OUTPUT SIGNAL	DMX512 (x2)
PROGRAMMABILITY	PC, MAC, Tablet, Smartphone
AVAILABLE COLORS	Black / White
CONNECTIONS	USB, Ethernet, RS232, Clock, 8dry contact ports, 5V output relay
MEMORY	microSD card
WORKING TEMP	-10°C ~ 45°C
MOUNTING	Single or double gang wall socket
WEIGHT (gross)	247g

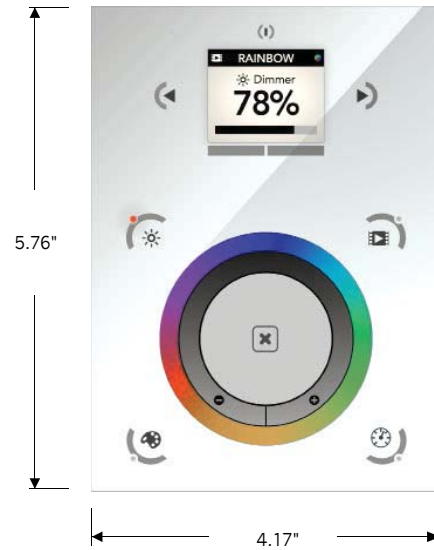

LSP-50RGB+W 4.4W Color Changing + White LED Strip

COMPATIBLE RGB CONTROLLERS

DMX SERIES	
------------	--

RGB-DMX4C

INPUT	12V - 24V DC
OUTPUT CURRENT	8A X 4CH
OUTPUT POWER	240W(12V), 720W (24V)
OUTPUT CHANNELS	3 or 4 selectable

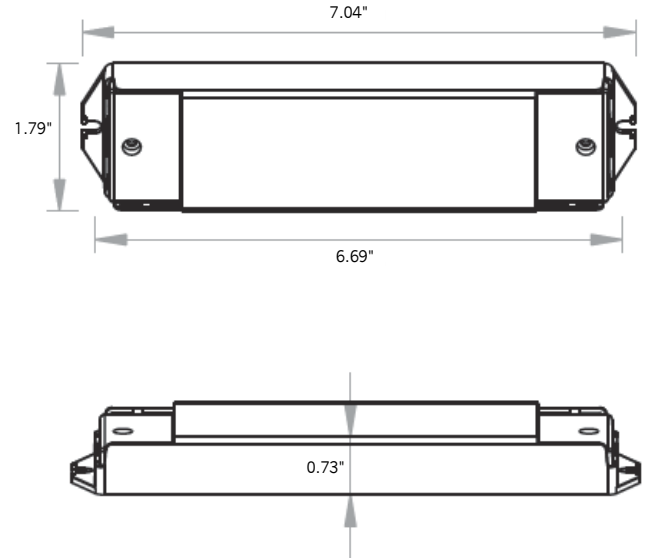

RGB-DMX5C-XLR

INPUT	12V-24V-36V DC
OUTPUT CURRENT	8A X 5CH

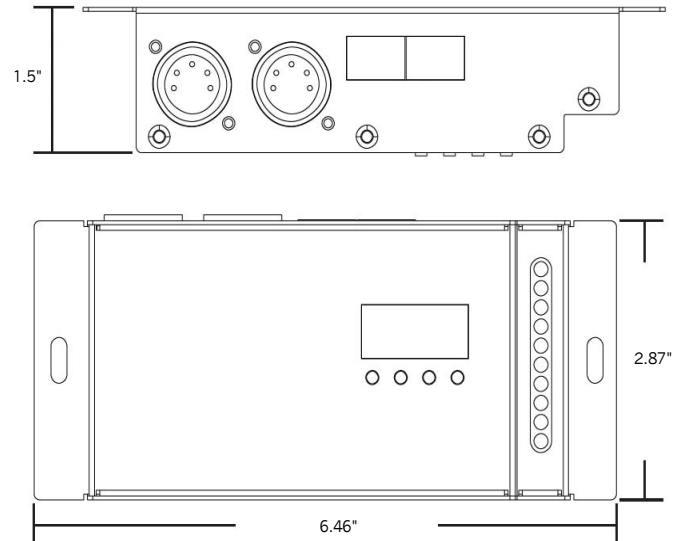

LSP-50RGB+W 4.4W Color Changing + White LED Strip

COMPATIBLE NON-DIMMING TRANSFORMERS

HARDWIRE CONSTANT VOLTAGE

PSHW SERIES		CLASS 2	L X W X H
PSHW-10W-24V	YES	2.55" X 1.37" X .90"	
PSHW-20W-24V	YES	4.64" X 1.38" X 1.2"	
PSHW-35W-24V	YES	5.83" X 1.57" X 1.18"	
PSHW-60W-24V	YES	6.38" X 1.65" X 1.18"	
PSHW-100W-24V	NO	7.44" X 2.4" X 1.45"	
PSHW-150W-24V	NO	8.75" X 2.68" X 1.53"	
PSHW-200W-24V	NO	9.62" X 2.68" X 1.53"	
PSHW-300W-24V	NO	9.92" X 3.55" X 1.75"	

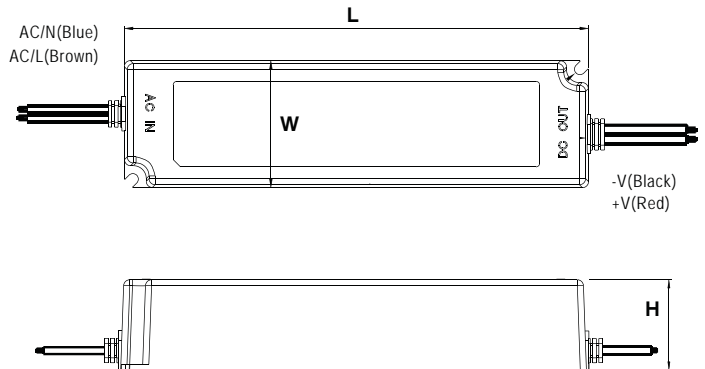

PSHK SERIES		CLASS 2	L X W X H
PSHK-30W-24V-UNV	YES	6.5" X 3.6" X 1.02"	
PSHK-60W-24V-UNV	YES	7.4" X 3.62" X 1.02"	
PSHK-96W-24V-UNV	YES	8.66" X 3.66" X 1.61"	
PSHK-150W-24V-UNV	NO	10.24" X 4.06" X 1.81"	
PSHK-200W-24V-UNV	NO	10.24" X 4.06" X 1.81"	
PSHK-300W-24V-UNV	NO	8.75" X 2.68" X 1.53"	
PSHW-200W-24V	NO	9.62" X 2.68" X 1.53"	
PSHW-300W-24V	NO	10.94" X 4.25" X 1.81"	

