

SPECIFICATION SHEET

JOB NAME: _____
 LOCATION: _____
 QUOTE/REF#: _____



LSP50RGB is a Color changing flexible LED strip that provides a full spectrum of color options using red, green and blue LED technology. The countless color mixing possibilities make RGB LEDs a diverse choice for even the most discerning in lighting solutions and applications. It can be easily installed onto most surfaces with double sided mounting tapes.

FEATURES

- Superior Color Rendering Index (CRI)
- Multiple CCT options available
- Up to 30 ft. of continuous linear light
- Architectural grade LED lighting
- Suitable for accent or ambient lighting

SPECIFICATIONS

INPUT VOLTAGE	12V and 24V DC constant voltage
POWER CONSUMPTION	4.4W per ft.
LUMEN OUTPUT	165 Lumens per ft.
NO. OF LEDs	18 LEDs per ft.
BEAM ANGLE	120°
CRI	90+
DIMMING	Through RGB controller
MAXIMUM RUN LENGTH	(12V) 20 ft. (24V) 30 ft.
FIELD CUTTABLE	(12V) every 2" (24) every 4"
IP RATING	IP45 (indoor/dry), IP65 (outdoor/wet)
LUMEN MAINTENANCE	50,000 Hrs
CERTIFICATIONS	UL Listed, TITLE 24
DIMENSIONS	Width x Depth: 0.47" x 0.15"

RGB COLOR SPECTRUM

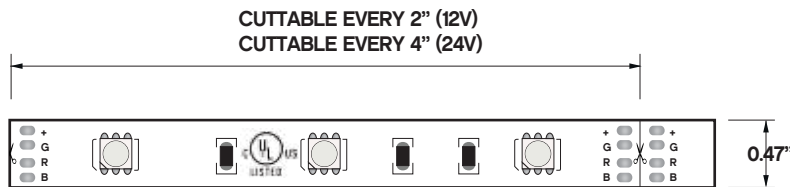
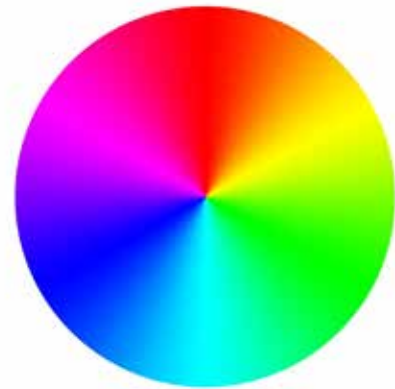

ORDERING GUIDE | EX: LSP-50RGB-100-24

MODEL	MODEL	LENGTH	VOLTAGE
LSP - Indoor LSPW - Outdoor	50RGB	16 - 16.4 FT. 100 - 100 FT. PF - PER FT. (12")	12 - 12V DC 24 - 24V DC

COMPATIBLE ALUMINUM PROFILES

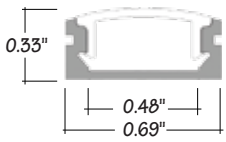

ALU-SF SURFACE MOUNT
LENGTHS 39^{3/8}" , 78^{7/8}" , 98"
LENS Clear , Frosted
FINISH Anodized Aluminum , Black

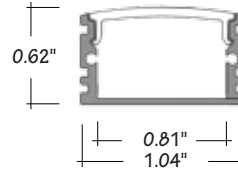

ALU-DS100 SURFACE MOUNT
LENGTHS 39^{3/8}" , 78"
LENS Clear and Frosted
FINISH Anodized Aluminum

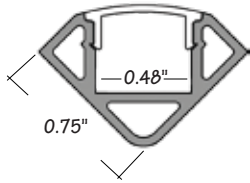

ALU-CN SURFACE / CORNER
LENGTHS 39^{3/8}" , 78^{7/8}" , 98"
LENS Clear , Frosted
FINISH Anodized Aluminum , Black

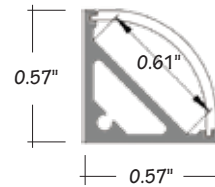

ALP-50C SURFACE / CORNER
LENGTHS 49.25" , 98.5"
LENS Frosted
FINISH Anodized Aluminum

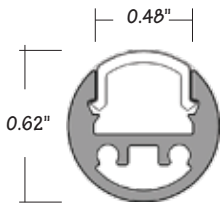

ALP-35 SURFACE MOUNT
LENGTHS 48" , 96"
LENS Frosted
FINISH Anodized Aluminum

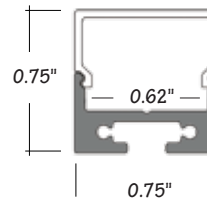

ALP-80 SURFACE / SUSPENDED
LENGTHS 49.25" , 98.5"
LENS Frosted
FINISH Anodized Aluminum

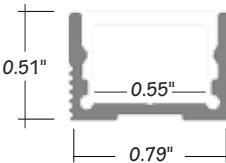

ALP-70 SURFACE MOUNT
LENGTHS 49.25" , 98.5"
LENS Frosted
FINISH Anodized Aluminum

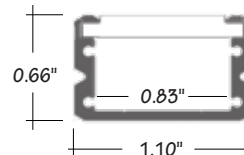

ALP-90 SURFACE MOUNT
LENGTHS 48" and 96"
LENS Frosted
FINISH Anodized Aluminum

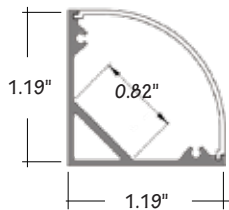

ALP-100C SURFACE / CORNER
LENGTHS 49.25" and 98.5"
LENS Frosted
FINISH Anodized Aluminum

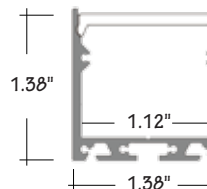

ALP-140 SURFACE / SUSPENDED
LENGTHS 49.25" and 98.5"
LENS Frosted
FINISH Anodized Aluminum

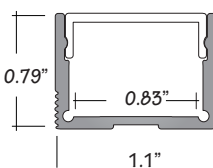

ALP-130 SURFACE / SUSPENDED
LENGTHS 49.25" and 98.5"
LENS Frosted
FINISH Anodized Aluminum

LSP-50RGB 4.4W Color Changing Indoor LED Strip

COMPATIBLE RGB CONTROLLERS

TOUCH SERIES														
RGB-CT330	RECEIVING CONTROLLER <table border="1"> <tr><td>INPUT</td><td>12V - 24V DC</td></tr> <tr><td>MAX OUTPUT CURRENT</td><td>3A X 3CH</td></tr> <tr><td>MAX OUTPUT POWER</td><td>108W(12V), 216W (24V)</td></tr> <tr><td>WORKING TEMP</td><td>-30°C ~ 55°C</td></tr> <tr><td>WEIGHT (gross)</td><td>135g</td></tr> </table>	INPUT	12V - 24V DC	MAX OUTPUT CURRENT	3A X 3CH	MAX OUTPUT POWER	108W(12V), 216W (24V)	WORKING TEMP	-30°C ~ 55°C	WEIGHT (gross)	135g			
	INPUT	12V - 24V DC												
MAX OUTPUT CURRENT	3A X 3CH													
MAX OUTPUT POWER	108W(12V), 216W (24V)													
WORKING TEMP	-30°C ~ 55°C													
WEIGHT (gross)	135g													
HANDHELD REMOTE <table border="1"> <tr><td>INPUT VOLTAGE</td><td>3V (CR2032 battery)</td></tr> <tr><td>WORKING FREQUENCY</td><td>433.92MHz</td></tr> <tr><td>REMOTE DISTANCE</td><td>90ft.</td></tr> <tr><td>WORKING TEMP</td><td>-30°C ~ 55°C</td></tr> <tr><td>WEIGHT (gross)</td><td>42g</td></tr> </table>	INPUT VOLTAGE	3V (CR2032 battery)	WORKING FREQUENCY	433.92MHz	REMOTE DISTANCE	90ft.	WORKING TEMP	-30°C ~ 55°C	WEIGHT (gross)	42g				
INPUT VOLTAGE	3V (CR2032 battery)													
WORKING FREQUENCY	433.92MHz													
REMOTE DISTANCE	90ft.													
WORKING TEMP	-30°C ~ 55°C													
WEIGHT (gross)	42g													
RGB-CT400	RECEIVING CONTROLLER <table border="1"> <tr><td>INPUT</td><td>12V - 24V DC</td></tr> <tr><td>MAX OUTPUT CURRENT</td><td>5A X 3CH, 15A Max</td></tr> <tr><td>MAX OUTPUT POWER</td><td>180W(12V), 360W (24V)</td></tr> <tr><td>CONTROL BUTTON</td><td>8 touch button</td></tr> <tr><td>WORKING TEMP</td><td>-30°C ~ 55°C</td></tr> <tr><td>WEIGHT (gross)</td><td>180g</td></tr> </table>	INPUT	12V - 24V DC	MAX OUTPUT CURRENT	5A X 3CH, 15A Max	MAX OUTPUT POWER	180W(12V), 360W (24V)	CONTROL BUTTON	8 touch button	WORKING TEMP	-30°C ~ 55°C	WEIGHT (gross)	180g	
	INPUT	12V - 24V DC												
MAX OUTPUT CURRENT	5A X 3CH, 15A Max													
MAX OUTPUT POWER	180W(12V), 360W (24V)													
CONTROL BUTTON	8 touch button													
WORKING TEMP	-30°C ~ 55°C													
WEIGHT (gross)	180g													
HANDHELD REMOTE (SOLD SEPARATELY) <table border="1"> <tr><td>INPUT VOLTAGE</td><td>5V DC (Built-in Lithium battery)</td></tr> <tr><td>WORKING CURRENT</td><td><30mA</td></tr> <tr><td>WORKING FREQUENCY</td><td>2.4GHz</td></tr> <tr><td>REMOTE DISTANCE</td><td>90ft.</td></tr> <tr><td>CHANGE MODE</td><td>32 modes</td></tr> <tr><td>WEIGHT (gross)</td><td>200g</td></tr> </table>	INPUT VOLTAGE	5V DC (Built-in Lithium battery)	WORKING CURRENT	<30mA	WORKING FREQUENCY	2.4GHz	REMOTE DISTANCE	90ft.	CHANGE MODE	32 modes	WEIGHT (gross)	200g		
INPUT VOLTAGE	5V DC (Built-in Lithium battery)													
WORKING CURRENT	<30mA													
WORKING FREQUENCY	2.4GHz													
REMOTE DISTANCE	90ft.													
CHANGE MODE	32 modes													
WEIGHT (gross)	200g													

LSP-50RGB 4.4W Color Changing Indoor LED Strip

COMPATIBLE RGB CONTROLLERS

WALL CONTROLLERS

RGB-CT600

INPUT VOLTAGE	5V DC, 1A
OUTPUT SIGNAL	RF 2.4GHz + DMX512
CONTROL	4 ZONES
WORKING TEMP	-30°C ~ 55°C
WEIGHT (gross)	370g

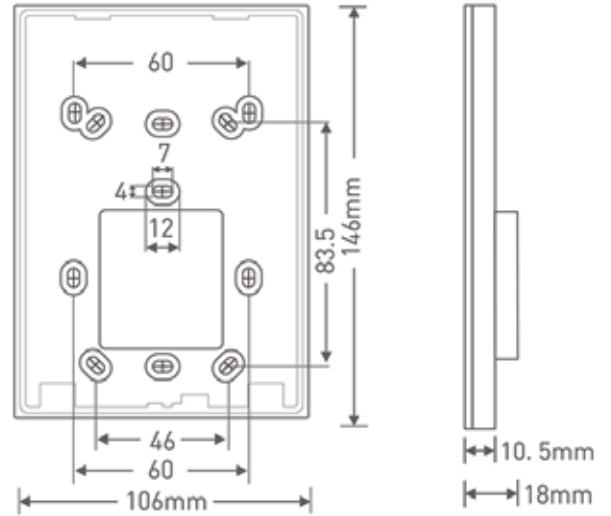

RGB-SDE3

INPUT POWER	6V DC 0.6A
OUTPUT SIGNAL	DMX512 (x2)
PROGRAMMABILITY	PC, MAC, Tablet, Smartphone
AVAILABLE COLORS	Black / White
CONNECTIONS	USB, Ethernet, RS232, Clock, 8dry contact ports, 5V output relay
MEMORY	microSD card
WORKING TEMP	-10°C ~ 45°C
MOUNTING	Single or double gang wall socket
WEIGHT (gross)	247g

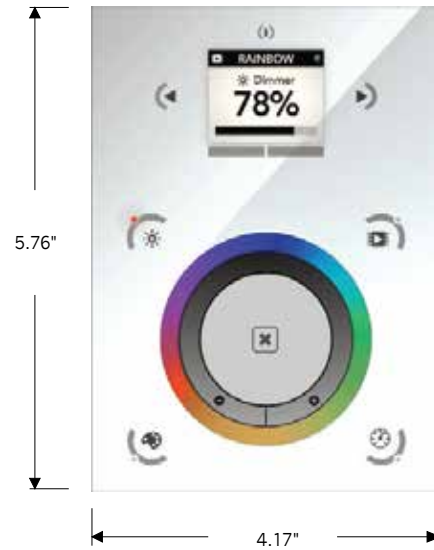

LSP-50RGB 4.4W Color Changing Indoor LED Strip

COMPATIBLE RGB CONTROLLERS

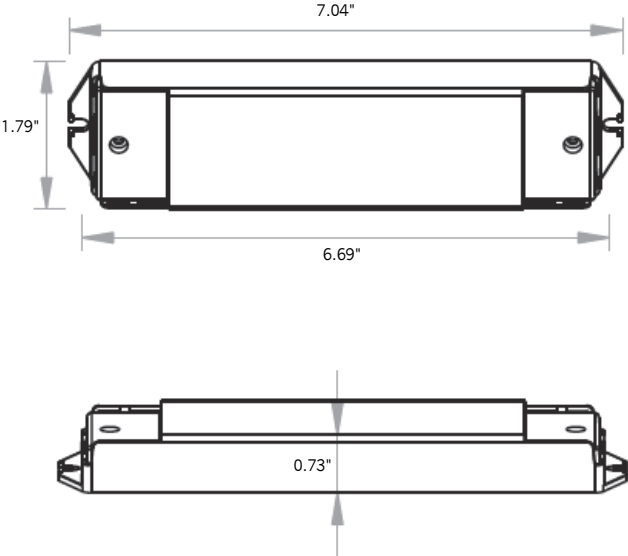
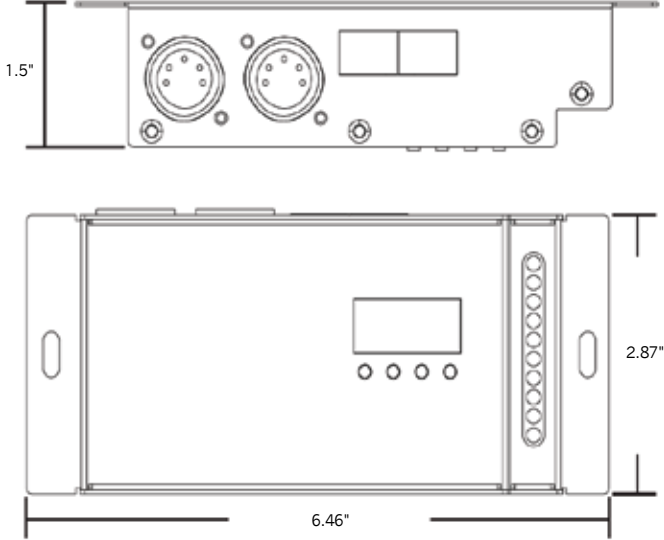
DMX SERIES									
<p>RGB-DMX4C</p> <table border="1" data-bbox="321 598 771 718"> <tr> <td>INPUT</td> <td>12V - 24V DC</td> </tr> <tr> <td>OUTPUT CURRENT</td> <td>8A X 4CH</td> </tr> <tr> <td>OUTPUT POWER</td> <td>240W(12V), 720W (24V)</td> </tr> <tr> <td>OUTPUT CHANNELS</td> <td>3 or 4 selectable</td> </tr> </table>	INPUT	12V - 24V DC	OUTPUT CURRENT	8A X 4CH	OUTPUT POWER	240W(12V), 720W (24V)	OUTPUT CHANNELS	3 or 4 selectable	
INPUT	12V - 24V DC								
OUTPUT CURRENT	8A X 4CH								
OUTPUT POWER	240W(12V), 720W (24V)								
OUTPUT CHANNELS	3 or 4 selectable								
<p>RGB-DMX5C-XLR</p> <table border="1" data-bbox="321 1392 771 1453"> <tr> <td>INPUT</td> <td>12V-24V-36V DC</td> </tr> <tr> <td>OUTPUT CURRENT</td> <td>8A X 5CH</td> </tr> </table>	INPUT	12V-24V-36V DC	OUTPUT CURRENT	8A X 5CH					
INPUT	12V-24V-36V DC								
OUTPUT CURRENT	8A X 5CH								

LSP-50RGB 4.4W Color Changing Indoor LED Strip

COMPATIBLE NON-DIMMING TRANSFORMERS

HARDWIRE CONSTANT VOLTAGE

		CLASS 2	L X W X H
PSHW SERIES 12V	PSHW-10W-12V	YES	2.55" X 1.37" X .90"
	PSHW-20W-12V	YES	4.64" X 1.38" X 1.2"
	PSHW-35W-12V	YES	5.83" X 1.57" X 1.18"
	PSHW-60W-12V	YES	6.38" X 1.65" X 1.18"
	PSHW-100W-12V	NO	7.44" X 2.4" X 1.45"
	PSHW-150W-12V	NO	8.75" X 2.68" X 1.53"
	PSHW-200W-12V	NO	9.62" X 2.68" X 1.53"
	PSHW-300W-12V	NO	9.92" X 3.55" X 1.75"

		CLASS 2	L X W X H
PSHW SERIES 24V	PSHW-10W-24V	YES	2.55" X 1.37" X .90"
	PSHW-20W-24V	YES	4.64" X 1.38" X 1.2"
	PSHW-35W-24V	YES	5.83" X 1.57" X 1.18"
	PSHW-60W-24V	YES	6.38" X 1.65" X 1.18"
	PSHW-100W-24V	NO	7.44" X 2.4" X 1.45"
	PSHW-150W-24V	NO	8.75" X 2.68" X 1.53"
	PSHW-200W-24V	NO	9.62" X 2.68" X 1.53"
	PSHW-300W-24V	NO	9.92" X 3.55" X 1.75"

