

SPECIFICATION SHEET

JOB NAME: _____
 LOCATION: _____
 QUOTE/REF#: _____

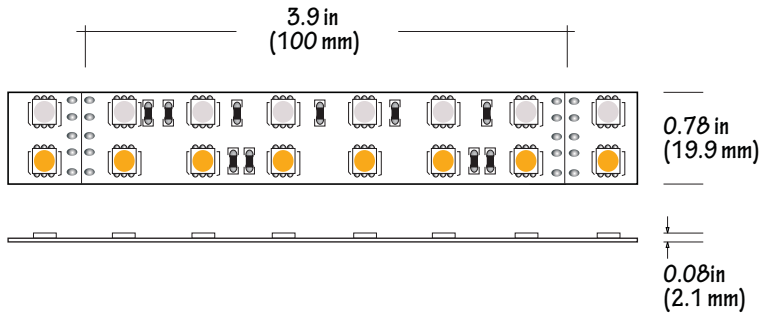

LSP80-RGBW is an indoor rated color-changing plus white LED strip that provides a full spectrum of color changing schemes. The warm or cool white LED's combined with the full color spectrum of the RGB light array produces more powerful color options that's sure to please even the most discerning lighting designer. Suitable for residential, commercial, hospitality and architectural lighting applications.

SPECIFICATIONS

INPUT VOLTAGE	24V DC
POWER CONSUMPTION	8.8W per foot
LUMEN OUTPUT	720 Lumens per foot
NO. OF LEDs	36 LEDs per foot
BEAM ANGLE	120°
CRI	90+
DIMMING	Through RGBW controller
MAXIMUM RUN LENGTH	20 Feet
FIELD CUTTABLE	Every 3.9 in (100MM)
IP RATING	IP45 dry location (indoor)
LUMEN MAINTENANCE	50,000 hrs.
OPERATING TEMPERATURE	-40°F(-40°C)~+140°F(+60°C)
BINNING	1.5 Step Macadam Elipse
CERTIFICATIONS	UL listed
DIMENSIONS	0.78" x 0.08 (width x height)

FEATURES

- 8.8W per Foot
- 720 Lumens
- 90+ CRI
- Two rows of high-output diodes
- 20 Feet Maximum Run Length
- Field cuttable
- Ideal for color-changing accent lighting
- Color changing + white
- UL Listed, Title 24 JA8 compliant
- Dimmable with RGBW controllers

RGBW COLOR SPECTRUM



LSP-80RGBW 8.8W Indoor RGB+White LED Strip

STANDARD ORDERING CODE

Model	Color Temp	Length	Voltage
LSP-80RGBW	RGBW27K - RGB + 2700K RGBW30K - RGB + 3000K RGBW40K - RGB + 4000K RGBW50K - RGB + 5000K	16 - 16.4 Ft. 32 - 32 Ft. PF - Per foot	24V - 24V DC

CUSTOMIZED LENGTH ORDERING CODE

Model	Color Temp	Length	Voltage	Profile
LSP-80RGBW	RGBW27K - RGB + 2700K RGBW30K - RGB + 3000K RGBW40K - RGB + 4000K RGBW50K - RGB + 5000K	XX - Custom Length	24V - 24V DC	See p3 for options

COMPATIBLE ALUMINUM PROFILES

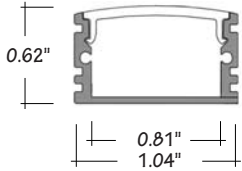

ALU-DS100 **SURFACE MOUNT**
LENGTHS 39³/₈" 78⁷/₈" 96"
LENS Clear and Frosted
FINISH Anodized Aluminum

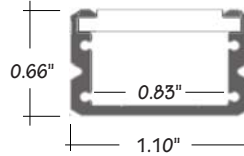

ALP-90 **SURFACE MOUNT**
LENGTHS 48" and 96"
LENS Frosted
FINISH Anodized Aluminum

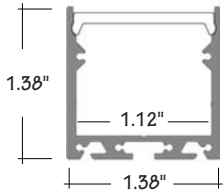

ALP-140 **SURFACE / SUSPENSION**
LENGTHS 49.25" , 98.5"
LENS Frosted
FINISH Anodized Aluminum

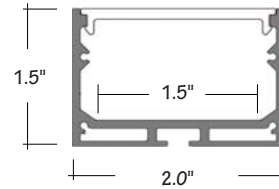

ALP-160 **SURFACE / SUSPENSION**
LENGTHS 49.25" , 98.5"
LENS Frosted
FINISH Anodized Aluminum

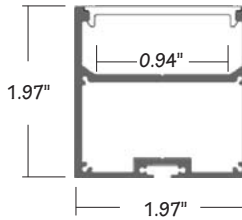

ALP-200 **SURFACE / SUSPENSION**
LENGTHS 49.25" , 98.5"
LENS Frosted
FINISH Anodized Aluminum

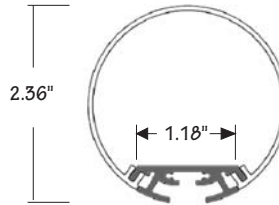

ALP-245 **SUSPENSION**
LENGTHS 49.25" , 98.5"
LENS Frosted
FINISH Anodized Aluminum

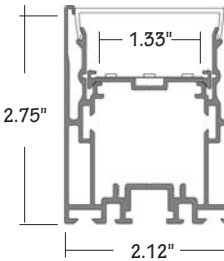

ALP-230N **SURFACE / SUSPENSION**
LENGTHS 49.25" , 98.5"
LENS Frosted
FINISH Anodized Aluminum

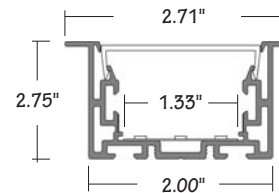

ALP-230RN **RECESSED**
LENGTHS 49.25" , 98.5"
LENS Frosted
FINISH Anodized Aluminum

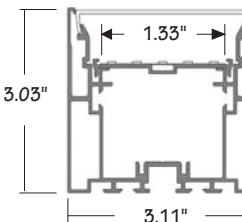

ALP-310N **SURFACE / SUSPENSION**
LENGTHS 49.25" , 98.5"
LENS Frosted
FINISH Anodized Aluminum

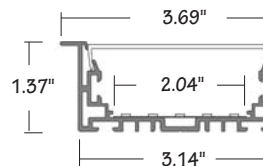

ALP-330RN **RECESSED**
LENGTHS 49.25" , 98.5"
LENS Frosted
FINISH Anodized Aluminum

LSP-80RGBW 8.8W Indoor RGB+White LED Strip

COMPATIBLE RGBW CONTROLLERS

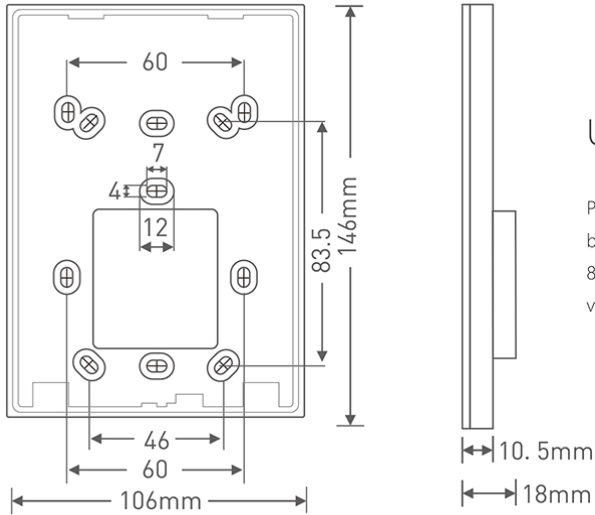

RGB-CT600

INPUT VOLTAGE	5V DC, 1A
OUTPUT SIGNAL	RF 2.4GHz + DMX512
CONTROL	4 ZONES
WORKING TEMP	-30°C ~ 55°C
WEIGHT (gross)	370g

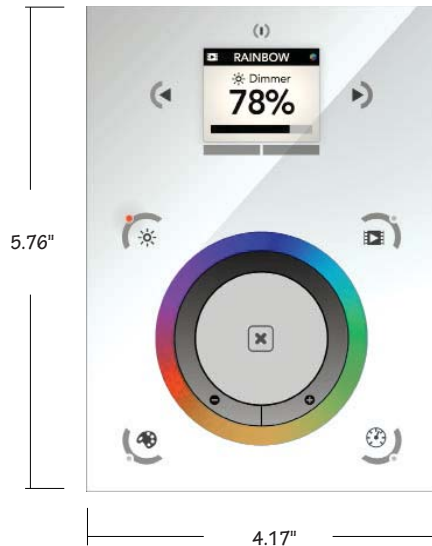

RGB-SDE3

INPUT POWER	6V DC 0.6A
OUTPUT SIGNAL	DMX512 (x2)
PROGRAMMABILITY	PC, MAC, Tablet, Smartphone
AVAILABLE COLORS	Black / White
CONNECTIONS	USB, Ethernet, RS232, Clock, 8dry contact ports, 5V output relay
MEMORY	microSD card
WORKING TEMP	-10°C ~ 45°C
MOUNTING	Single or double gang wall socket
WEIGHT (gross)	247g

LSP-80RGBW 8.8W Indoor RGB+White LED Strip

COMPATIBLE RGBW CONTROLLERS

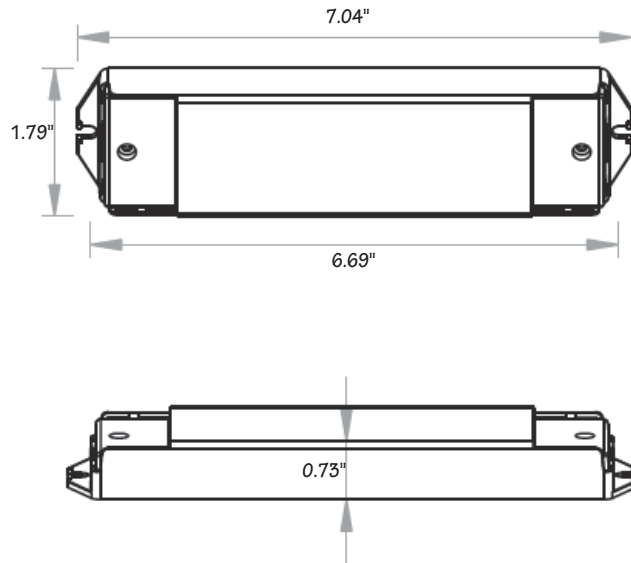

RGB-DMX4C

INPUT	12V - 24V DC
OUTPUT CURRENT	8A X 4CH
OUTPUT POWER	240W(12V), 720W (24V)
OUTPUT CHANNELS	3 or 4 selectable

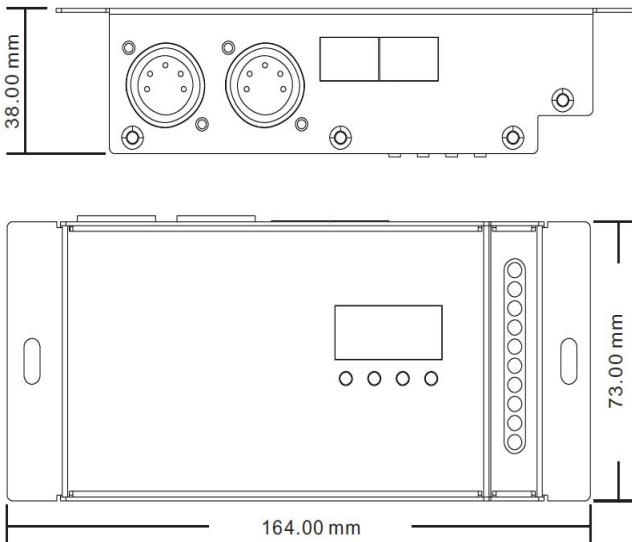

RGB-DMX5C-XLR

INPUT	12V-24V-36V DC
OUTPUT CURRENT	8A X 5CH

LSP-80RGBW 8.8W Indoor RGB+White LED Strip

COMPATIBLE TRANSFORMERS



PSHK SERIES NON-DIMMING WITH JUNCTION BOX

PSHK-30W-24V-UNV	CLASS 2	6.5" X 3.6" X 1.02"
PSHK-60W-24V-UNV	CLASS 2	7.4" X 3.62" X 1.02"
PSHK-96W-24V-UNV	CLASS 2	8.66" X 3.66" X 1.61"
PSHK-150W-24V-UNV		10.24" X 4.06" X 1.81"
PSHK-200W-24V-UNV		10.24" X 4.06" X 1.81"
PSHK-300W-24V-UNV		10.94" X 4.25" X 1.81"