

SPECIFICATION SHEET

JOB NAME: _____
 LOCATION: _____
 QUOTE/REF#: _____

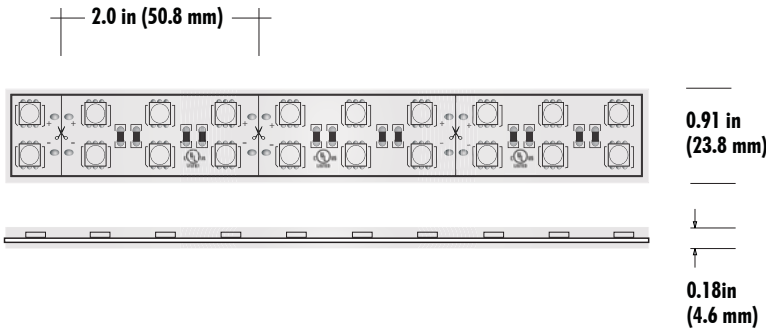

LSPW80-RGB super High Output color changing LED strip is designed to produce more than 720 lumens at 8.8 Watts per foot. It is an outdoor strip that provides a full spectrum of color options using red, green and blue LED technology. This LED strip is offered in a low profile design that can be attached almost anywhere and are great for many common lighting applications, such as cove lighting or cabinets. LSP-80 series produces a 160° light beam spread and is offered in different color temperatures to fit your specific needs. UL listed.

SPECIFICATIONS

INPUT VOLTAGE	24V DC
POWER CONSUMPTION	8.8W per foot
LUMEN OUTPUT	720 lm
NO. OF LEDs	36 LEDs per foot
BEAM ANGLE	120°
CRI	90+
DIMMING	Through RGB controller
MAXIMUM RUN LENGTH	20 feet
FIELD CUTTABLE	Every 2.0" (50.8MM)
IP RATING	IP65 wet location (outdoor)
LUMEN MAINTENANCE	50,000 hrs.
OPERATING TEMPERATURE	-40°F(-40°C)~+140°F(+60°C)
BINNING	1.5 Step Macadam Elipse
CERTIFICATIONS	UL listed, TITLE 24 JA8
DIMENSIONS	0.91" x 0.18 (width x height)

FEATURES

- 8.8W per Foot
- 720 Lumens
- 95+ CRI
- California **TITLE 24 JA8** compliant
- Field cuttable
- Suitable for accent or ambient lighting
- IP65 outdoor wet rated
- Superior COLOR RENDERING INDEX (CRI)
- Available in 24V
- UL Listed
- Dimmable with **CORE Lighting** dimmable drivers

SPECIFICATIONS



LSPW80-RGB 8.8W Outdoor Color-Changing LED Strip



STANDARD ORDERING CODE

Model	Color Temp	Length	Voltage
LSPW-80	RGB - RGB	16 - 16.4 Ft. 32 - 32 Ft. PF - Per foot	24V - 24V DC

CUSTOMIZED LENGTH ORDERING CODE

Model	Color Temp	Length	Voltage	Profile
LSPW-80	RGB - RGB	XX - Custom Length	24V - 24V DC	See p3

LSPW80-RGB 8.8W Outdoor Color-Changing LED Strip

COMPATIBLE ALUMINUM PROFILES

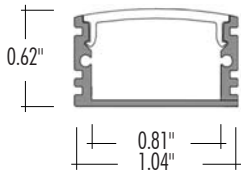

ALU-DS100 | SURFACE MOUNT
LENGTHS 39 ^{3/8}" and 78 ^{7/8}"
LENS Clear & Frosted
FINISH Anodized Aluminum

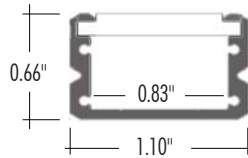

ALP-90 | SURFACE MOUNT
LENGTHS 48" and 96"
LENS Frosted
FINISH Anodized Aluminum

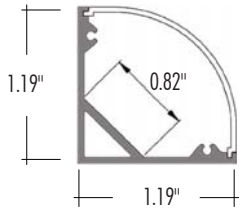

ALP-100C | SURFACE / CORNER MOUNT
LENGTHS 49.25" and 98.5"
LENS Frosted
FINISH Anodized Aluminum

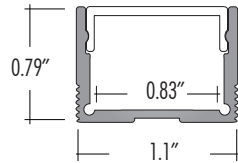

ALP-130 | SURFACE / SUSPENSION MOUNT
LENGTHS 49.25" and 98.5"
LENS Frosted
FINISH Anodized Aluminum

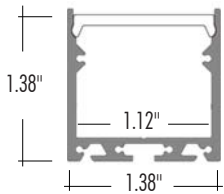

ALP-140 | SURFACE / SUSPENSION MOUNT
LENGTHS 49.25" and 98.5"
LENS Frosted
FINISH Anodized Aluminum

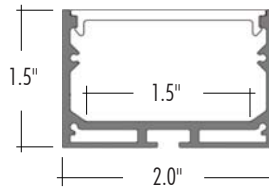

ALP-160 | SURFACE / SUSPENSION MOUNT
LENGTHS 49.25" and 98.5"
LENS Frosted
FINISH Anodized Aluminum

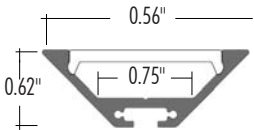

ALP-190 | SURFACE / SUSPENSION MOUNT
LENGTHS 49.25" and 98.5"
LENS Frosted
FINISH Anodized Aluminum

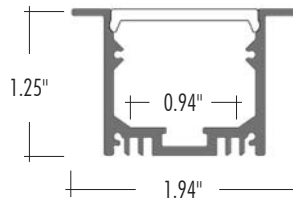

ALP-200R | RECESSED MOUNT
LENGTHS 49.25" and 98.5"
LENS Frosted
FINISH Anodized Aluminum

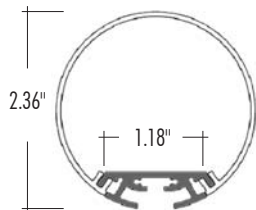

ALP-245 | SUSPENSION MOUNT
LENGTHS 49.25" and 98.5"
LENS Frosted
FINISH Anodized Aluminum

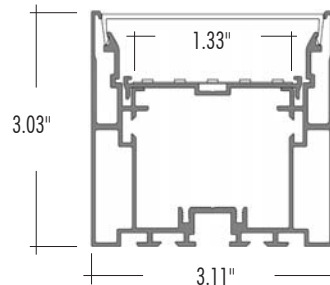

ALP-310N | SURFACE / SUSPENSION MOUNT
LENGTHS 49.25" and 98.5"
LENS Frosted
FINISH Anodized Aluminum

LSPW80-RGB 8.8W Outdoor Color-Changing LED Strip

COMPATIBLE TOUCH SERIES CONTROLLERS

RGB-CT330

**RECEIVING CONTROLLER
INPUT
MAX OUTPUT CURRENT
MAX OUTPUT POWER
WORKING TEMP
WEIGHT (gross)**

12V - 24V DC
3A X 3CH
108W(12V), 216W (24V)
-30°C ~ 55°C
135g

RECEIVER

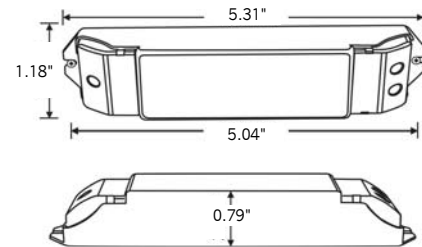

**HANDHELD REMOTE
INPUT VOLTAGE
WORKING FREQUENCY
REMOTE DISTANCE
WORKING TEMP
WEIGHT (gross)**

3V (CR2032 battery)
433.92MHz
90ft.
-30°C ~ 55°C
42g

HANDHELD REMOTE

REMOTE CRADLE

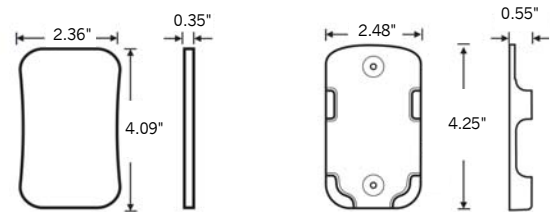

RGB-CT400

**RECEIVING CONTROLLER
INPUT
MAX OUTPUT CURRENT
MAX OUTPUT POWER
CONTROL BUTTON
WORKING TEMP
WEIGHT (gross)**

12V - 24V DC
5A X 3CH, 15A Max
180W(12V), 360W (24V)
8 touch button
-30°C ~ 55°C
180g

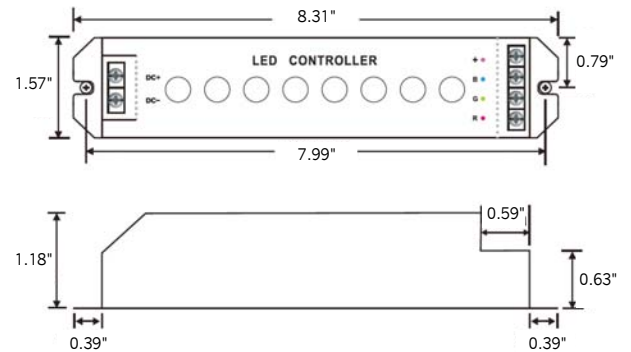

**RGB-CT400RX
(SOLD SEPARATELY)**

**HANDHELD REMOTE
INPUT VOLTAGE
WORKING CURRENT
WORKING FREQUENCY
REMOTE DISTANCE
CHANGE MODE
WEIGHT (gross)**

5V DC (Built-in Lithium battery)
< 30mA
2.4GHz
90ft.
32 modes
200g

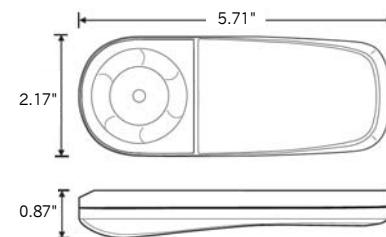

HANDHELD REMOTE

COMPATIBLE WALL CONTROLLERS

RGB-CT600	INPUT VOLTAGE	5V DC, 1A
	OUTPUT SIGNAL	RF 2.4GHz + DMX512
	CONTROL	4 ZONES
	WORKING TEMP	-30°C ~ 55°C
	WEIGHT (gross)	370g

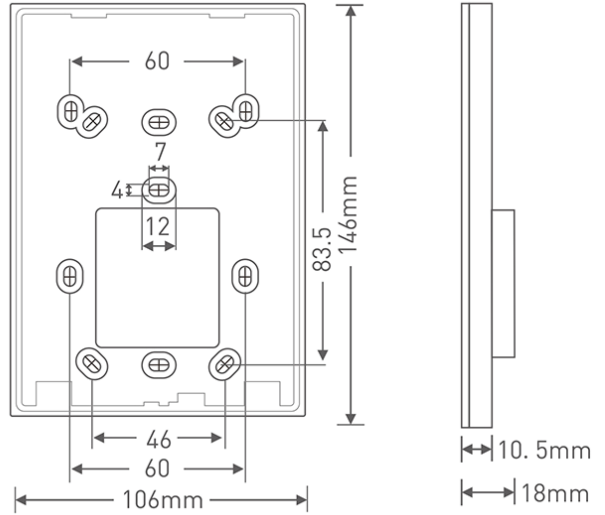

RGB-SDE3	INPUT POWER	6V DC 0.6A
	OUTPUT SIGNAL	DMX512 (x2)
	PROGRAMMABILITY	PC, MAC, Tablet, Smartphone
	AVAILABLE COLORS	Black / White
	CONNECTIONS	USB, Ethernet, RS232, Clock, 8dry contact ports, 5V output relay
MEMORY	microSD card	
WORKING TEMP	-10°C ~ 45°C	
MOUNTING	Single or double gang wall socket	
WEIGHT (gross)	247g	

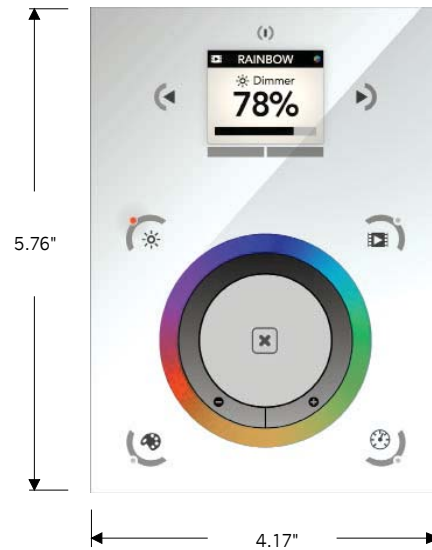

LSPW80-RGB 8.8W Outdoor Color-Changing LED Strip

COMPATIBLE DMX RECEIVERS

RGB-DMX4C

INPUT
OUTPUT CURRENT
OUTPUT POWER
OUTPUT CHANNELS

12V - 24V DC
8A X 4CH
240W(12V), 720W (24V)
3 or 4 selectable

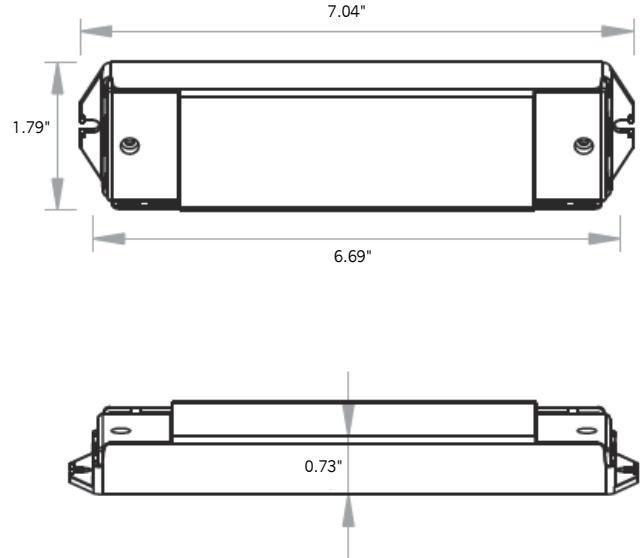

RGB-DMX5C-XLR

INPUT
OUTPUT CURRENT

12V-24V-36V DC
8A X 5CH

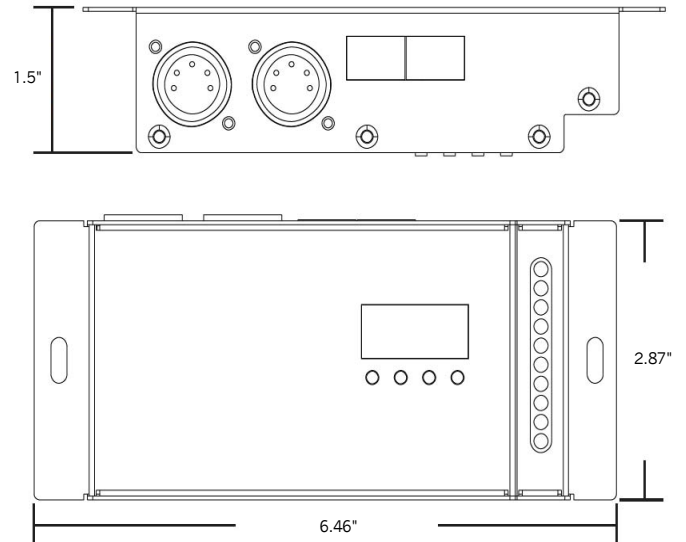

COMPATIBLE NON-DIMMING TRANSFORMERS

PSHW SERIES	PSHW-10W-12V	CLASS 2	L X W X H
12V	PSHW-10W-12V	YES	2.55" X 1.37" X .90"
	PSHW-20W-12V	YES	4.64" X 1.38" X 1.2"
	PSHW-35W-12V	YES	5.83" X 1.57" X 1.18"
	PSHW-60W-12V	YES	6.38" X 1.65" X 1.18"
	PSHW-100W-12V	NO	7.44" X 2.4" X 1.45"
	PSHW-150W-12V	NO	8.75" X 2.68" X 1.53"
	PSHW-200W-12V	NO	9.62" X 2.68" X 1.53"
	PSHW-300W-12V	NO	9.92" X 3.55" X 1.75"

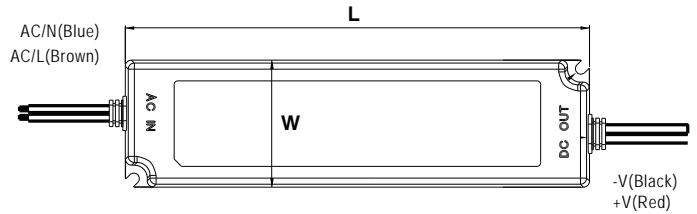

PSHW SERIES	PSHW-10W-24V	CLASS 2	L X W X H
24V	PSHW-10W-24V	YES	2.55" X 1.37" X .90"
	PSHW-20W-24V	YES	4.64" X 1.38" X 1.2"
	PSHW-35W-24V	YES	5.83" X 1.57" X 1.18"
	PSHW-60W-24V	YES	6.38" X 1.65" X 1.18"
	PSHW-100W-24V	NO	7.44" X 2.4" X 1.45"
	PSHW-150W-24V	NO	8.75" X 2.68" X 1.53"
	PSHW-200W-24V	NO	9.62" X 2.68" X 1.53"
	PSHW-300W-24V	NO	9.92" X 3.55" X 1.75"

