

SPECIFICATION SHEET

JOB NAME: _____
 LOCATION: _____
 QUOTE/REF#: _____



LSRN40 SERIES is a high performance, water-resistant LED strip designed for all-weather and harsh environments. Manufactured with a patented epoxy PVC material that makes the LED strip resistant to saltwater, chlorine, rain, and humidity.

FEATURES

- Integrated frosted diffuser
- High quality and brightness
- IP65 outdoor rated, water resistant
- Multiple CCT options available
- Dimmable
- Environment friendly and energy efficient

SPECIFICATIONS

INPUT VOLTAGE	24V DC Constant Voltage
POWER CONSUMPTION	3.8W per ft.
LUMEN OUTPUT	140 Lumens per Ft.
BEAM ANGLE	120°
CRI	90
DIMMING	MLV, ELV, 0-10 and TRIAC
MAXIMUM RUN LENGTH	32 Ft.
IP RATING	IP65
LUMEN MAINTENANCE	50,000 Hours
MOUNTING	Aluminum & PVC Mounting Channel (sold separately)
OPERATING TEMPERATURE	-4°F ~ 122°F (-20°C ~ 50°C)
STORAGE TEMPERATURE	-4°F ~ 176°F (-20°C ~ 80°C)
CUTTING LENGTH	Every 3.3" (83.82MM)
CERTIFICATIONS	UL Listed
DIMENSIONS	Width x Depth: 0.50" x 0.22"

	COLOR TEMP	CRI	LUMENS
	2700K	90	140
	3000K	90	140
	4000K	90	140

CANDLE POWER DISTRIBUTION

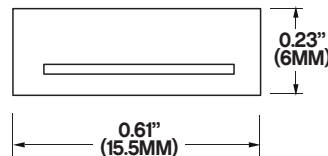
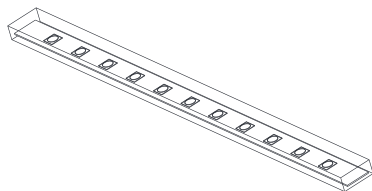
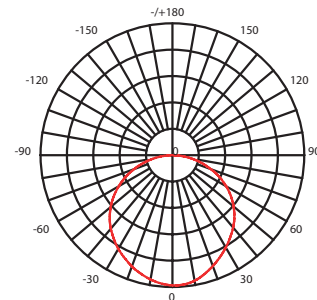

3.8W
PER FT.

90
CRI

OUTDOOR

INDOOR

50,000
HOURS

DIMMABLE

WARRANTY
5 YEAR
WARRANTY

ORDERING GUIDE

EXAMPLE: LSRN40-30K-32-24-IP65BF-HW10

LSRN40					
MODEL	COLOR TEMPERATURE	LENGTH	VOLTAGE	POWER FEED	POWER FEED LENGTH
	27K - 2700K 30K - 3000K 40K - 4000K	16 - 16.4ft. 32 - 32ft. PF - 12"	24 - 24 Volts	IP65BF - Bottom Feed IP65SFL - Side Feed Left IP65SFR - Side Feed Right IP65EF - End Feed	HW3 - 3FT Power Feed HW10 - 10FT Power Feed

IP65 POWER FEED

IP65BF - BOTTOM FEED

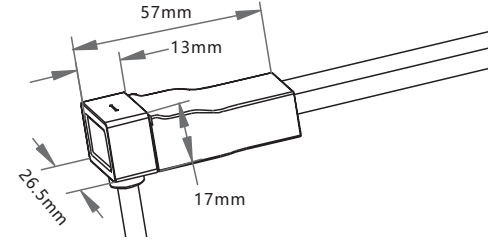

IP65SFL - SIDE FEED LEFT
IP65SFR - SIDE FEED RIGHT

LEFT



RIGHT

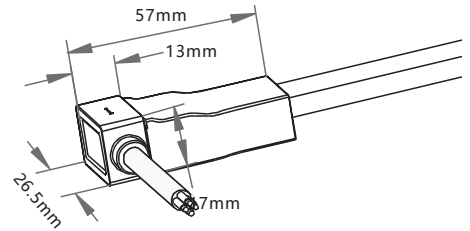

IP65EF - END FEED

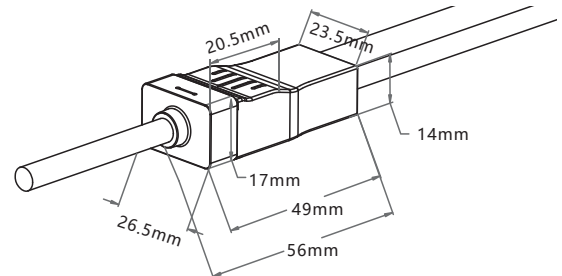

IP65EC - END CAP

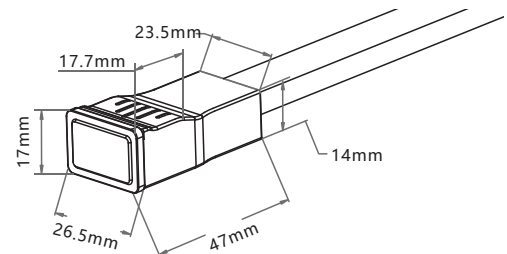

LSRN40 SERIES 3.8W IP65 OUTDOOR LED STRIP

COMPATIBLE DIMMABLE TRANSFORMERS

MAGNETIC LOW VOLTAGE (MLV)			
	CLASS 2	L X W X H	
PSDM SERIES	PSDM-20W-12V	YES	5.6" X 2" X 2.14"
	PSDM-40W-12V	YES	5.6" X 2" X 2.14"
	PSDM-60W-12V	YES	6.5" X 2.3" X 2.5"
	PSDM-100W-12V	NO	9.8" X 3" X 3"
	PSDM-150W-12V	NO	9.8" X 3" X 3"
	PSDM-180W-12V-CL2	YES	9.8" X 3" X 3"
	PSDM-200W-12V	NO	9.8" X 3" X 3"
	PSDM-300W-12V	NO	9.8" X 4.2" X 3.5"
	PSDM-300W-12V-CL2	YES	7.0" X 7.0" X 3.2"
PSDM SERIES	PSDM-20W-24V	YES	5.6" X 2" X 2.14"
	PSDM-40W-24V	YES	5.6" X 2" X 2.14"
	PSDM-60W-24V	YES	6.5" X 2.2" X 2.5"
	PSDM-100W-24V-CL2	YES	6.5" X 2.2" X 2.5"
	PSDM-150W-24V	NO	9.8" X 3" X 3"
	PSDM-192W-24V-CL2	YES	7.0" X 7.0" X 3.2"
	PSDM-200W-24V	NO	9.8" X 3" X 3"
	PSDM-300W-24V	NO	9.8" X 4.2" X 3.5"
	PSDM-288W-24V-CL2	YES	7.0" X 7.0" X 3.2"

* 277 VERSIONS AVAILABLE, PLEASE CONSULT FACTORY

HIGH PERFORMANCE MLV			
	CLASS 2	L X W X H	
PSDH SERIES	PSDH-48W-24V	YES	11.25" X 3.37" X 3.25"
	PSDH-96W-24V	YES	11.25" X 3.37" X 3.25"
	PSDH-288W-24V	YES	14.25" X 8.43" X 4.43"

* 277 VERSIONS AVAILABLE, PLEASE CONSULT FACTORY

TRIAC DIMMING ELECTRONIC			
PSDL 24V SERIES TRIAC DIMMABLE			
PSDL-30W-24V	CLASS 2	6.5" x 3.63" x 1.03"	
PSDL-60W-24V	CLASS 2	7.4" x 3.63" x 1.03"	
PSDL-96W-24V	CLASS 2	8.67" x 3.67" x 1.62"	
PSDL-150W-24V	CLASS 2	8.67" x 3.67" x 1.62"	
PSDL-192W-24V		10.25" x 4.06" x 1.82"	
PSDL-200W-24V		10.25" x 4.06" x 1.82"	
PSDL-288W-24V		10.25" x 4.06" x 1.82"	
PSDL-300W-24V		10.25" x 4.06" x 1.82"	

LSRN40 SERIES 3.8W IP65 OUTDOOR LED STRIP

COMPATIBLE DIMMABLE TRANSFORMERS

0-10 DIMMING WITH JUNCTION BOX

	CLASS 2	L X W X H
PSDE SERIES	PSDE-100W-24V-010-JB	YES 12.32" X 1.77" X 1.67"

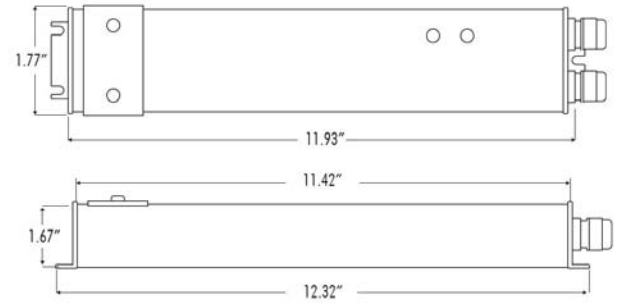

LUTRON 1% DIMMING

	CLASS 2	L X W X H
2-WIRE	LTEA4U1UKL-CV240	YES 4.0" X 1.5" X 4.0"
3-WIRE	L3DA4U1UKL-CV240	YES 4.0" X 1.5" X 4.0"

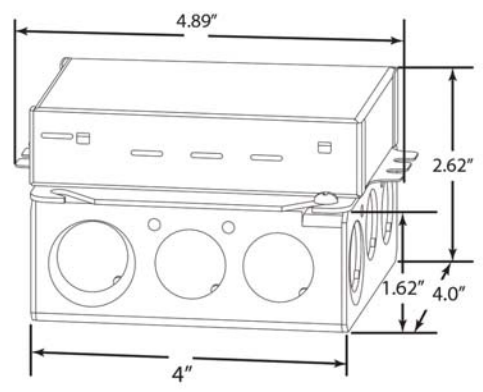

LUTRON .1% DIMMING

	CLASS 2	L X W X H
PSDE SERIES	PSDE-96W-24V-ECO	YES 10.5" X 3.0" X 2.0"

