

# FINELITE

## High Performance 4" Aperture (HP-4) - Surface Mount



Date

Project

Type

Comments

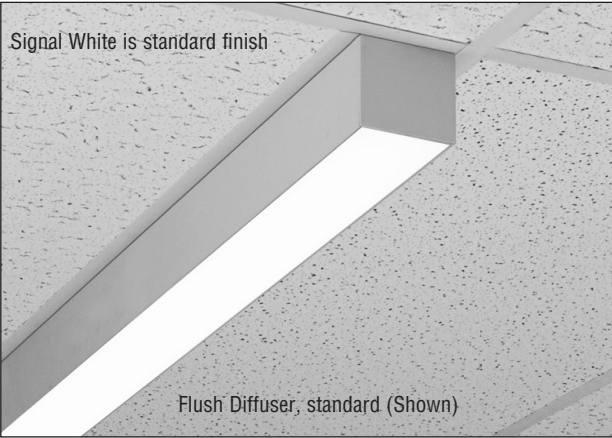

Note: See Page 2 for all aesthetic options

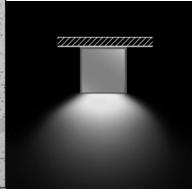

### DESCRIPTION

[GET A QUOTE >](#)

High Performance 4" aperture Surface Mount (HP-4 SM) is a patented, linear LED luminaire that offers many aesthetic options including Flush, Bottom Glow™, 1" Drop Down Lens, Regressed diffuser, White Cross Blade Baffle, Hollowed Ellipse Louver, or Hex Louver for downlight. HP-4 SM delivers excellent performance using an advanced optical design and mid-power LEDs to achieve 90% of initial light output at 100,000+ hours.

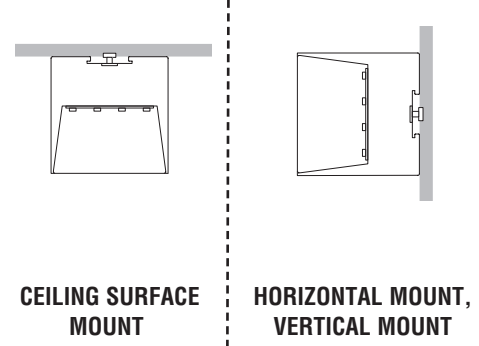
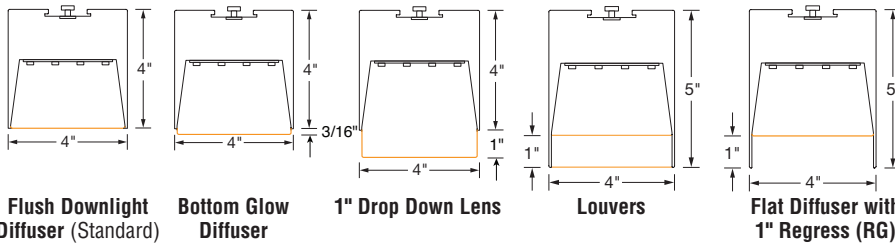

### AESTHETIC SOLUTIONS

Offering multiple aesthetic choices with Flush, Bottom Glow, 1" Drop Down Lens, Louvers, and Regressed diffusers.

### ORDERING GUIDE - Sample Number: HP-4 SM - 32' - S - 835 - F - 120V - C1 - FE - SC - OBO

Finelite HP-4 SM	<input type="checkbox"/>
HP-4 SM RG	<input type="checkbox"/>
Length (Minimum 2', increments accurate to 1/16th" (± 1/32"), standard)	<input type="text"/>
Light Output (S - Standard Output, B - Boosted Standard Output, H - High Output, V - Very High Output)	<input type="text"/>
LED CRI/CCT (830 - 80 CRI min, 3000K 930 - 90 CRI min, 3000K; 835 - 80 CRI min, 3500K 935 - 90 CRI min, 3500K; 840 - 80 CRI min, 4000K 940 - 90 CRI min, 4000K)	<input type="text"/>
Downlight Option (F <sup>1</sup> - Flush (standard), BG <sup>1</sup> - Bottom Glow, DL <sup>1</sup> - 1" Drop Down Lens, RG-D2 - Flat Diffuser with 1" Regress, RG-WCB <sup>2,3</sup> - White Cross Blade Baffle, RG-LHE <sup>2,3</sup> - Hollowed Ellipse Louver, RG-LHC <sup>2,3</sup> - Hex Louver)	<input type="text"/>
Voltage (120V, 277V, 347V)	<input type="text"/>
Mounting (C1 - 1" T-Bar, C2 - 9/16" T-Bar, C3 - screw slot, C4 - hard ceiling / wall)	<input type="text"/>
Endcap (FE - Flat Endcap, DE <sup>4</sup> - 1" Drop Down Lens Illuminated Endcap, OE <sup>5</sup> - Open Endcap)	<input type="text"/>
Circuiting <sup>6</sup> (SC - Single Circuit)	<input type="text"/>
Integrated Sensor <sup>7</sup> (OBO - Occupancy Sensor, OBD - Daylight)	<input type="text"/>

<sup>1</sup> Available for HP-4 Surface Mount (HP-4 SM) only  
<sup>2</sup> Available for HP-4 Surface Mount Regressed (HP-4 SM RG) only  
<sup>3</sup> Available in 1" increments  
<sup>4</sup> Available for 1" Drop Down Lens (DL) downlight option only  
<sup>5</sup> Available with Hollowed Ellipse Louver (LHE) only  
<sup>6</sup> Contact factory for switching options  
<sup>7</sup> Available with Flush (F), Bottom Glow (BG), White Cross Blade Baffle (WCB), and Regressed (RG) downlight diffusers

Protected by one or more US Patents: 8915613; D702,391; D702,390; D700,732

A brand of LeGrand

Finelite, Inc. • 30500 Whipple Road • Union City, CA 94587-1530 • (510) 441-1100 • Fax: (510) 441-1510 • www.finelite.com

# FINELITE

## High Performance 4" Aperture (HP-4) - Surface Mount

### AESTHETIC OPTIONS

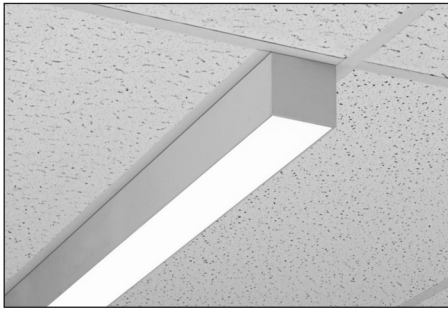

Flush Diffuser (F)

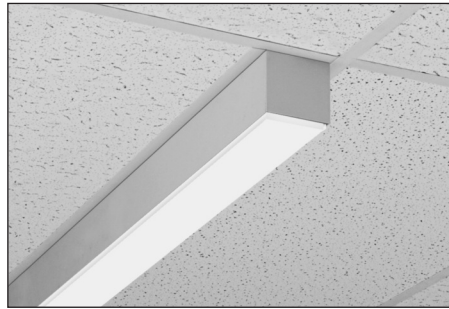

Bottom Glow Diffuser (BG)

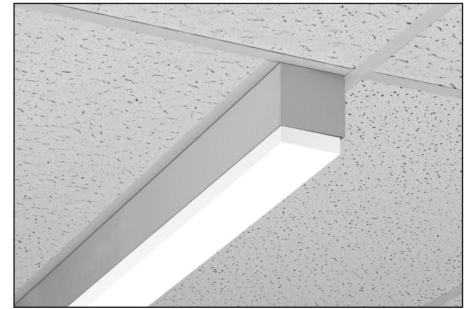

1" Drop Down Lens (DL)

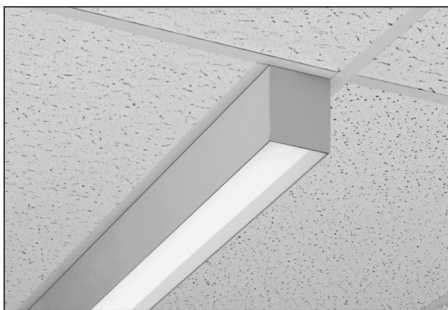

Flat Diffuser with 1" Regress (RG-D)

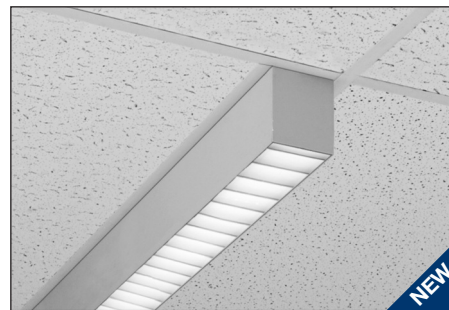

White Cross Blade Baffle (RG-WCB)

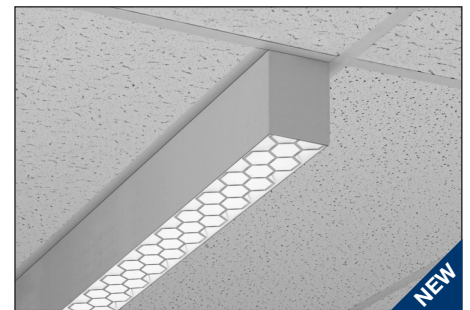

Hollowed Ellipse Louver (RG-LHE)

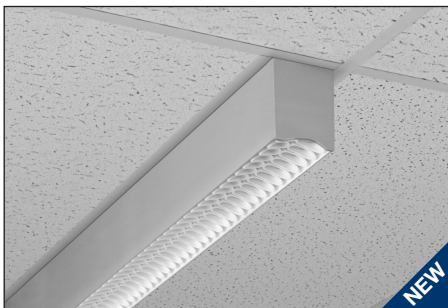

Hex Louver (RG-LHC)

# FINELITE

## High Performance 4" Aperture (HP-4) - Surface Mount

### PHOTOMETRY

#### DOWNLIGHT: FLUSH DIFFUSER

HP-4-D-V-835

Very High Output - 4' Luminaire

Efficacy: 100.1 lumens per watt

Total luminaire output: 3705 Lumens (926 lumens/foot)  
37 Watts (9.3 watts/foot)

Peak Candela Value: 1436 @ 0°

CCT: 3500K

ITL LM79 Report 85124

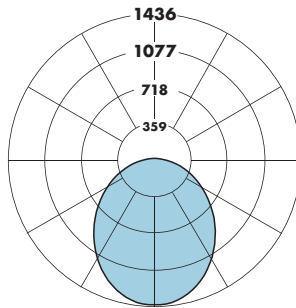

CANDLEPOWER SUMMARY						
	0.0	22.5	45	67.5	90	Flux
0	1436	1436	1436	1436	1436	
5	1428	1428	1427	1427	1427	135
15	1363	1353	1358	1357	1350	382
25	1236	1221	1226	1219	1212	563
35	1060	1047	1048	1037	1030	653
45	859	849	848	836	831	652
55	647	639	637	628	623	568
65	434	432	431	425	424	425
75	236	236	237	235	236	250
85	67	68	69	70	69	77
90	0	0	0	0	0	

Total Light Output, 3500K, 80 CRI (Lumens) - 4' Luminaire			
S*	B*	H*	V**
1517	1907	2882	3705

Light Output, 3500K, 80 CRI (Lumens Per Foot)			
S*	B*	H*	V**
379	477	720	926

Power (Watts Per Foot)			
S*	B*	H*	V**
3.6	4.6	7.1	9.3

Efficacy, 3500K, 80 CRI (Lumens Per Watt)			
S*	B*	H*	V**
105	104	102	100

S - Standard Output, B - Boosted Standard Output, H - High Output, V - Very High Output

\* Family Correlation based on 4' luminaire 3500K 80 CRI Very High Output (V) test - 120V.

\*\* Based on ITL report: 85124

Lumen Adjustment Factors - 80 CRI	
3000K	0.985
3500K	1.000
4000K	1.032

Lumen Adjustment Factors - 90 CRI	
3000K	0.746
3500K	0.760
4000K	0.789

Apply a lumen adjustment factor to calculate lumens for the desired CCT and CRI.

### SAMPLE LUMEN ADJUSTMENT CALCULATION

High Output (H), 4000K, 90 CRI

Lumen Adjustment Factor = 0.789

$$\begin{aligned} \text{Total Light Output} &= \\ 2882 \text{ lm} \times 0.789 &= 2274 \text{ lm} \end{aligned}$$

$$\begin{aligned} \text{Total Light Output per Foot} &= \\ 720 \text{ lm/ft} \times 0.789 &= 568 \text{ lm/ft} \end{aligned}$$

$$\text{watts/foot} = 7.1 \text{ W/ft}$$

$$\text{Efficacy} = \frac{568 \frac{\text{lm}}{\text{ft}}}{7.1 \frac{\text{W}}{\text{ft}}} = 80 \text{ lm/W}$$

# FINELITE

## High Performance 4" Aperture (HP-4) - Surface Mount

### PHOTOMETRY

**DOWNLIGHT: 1" DROP DOWN LENS**

HP-4-D-V-835-DL

Very High Output - 4' Luminaire

Efficacy: 111 Lumens per watt

Total Luminaire Output: 4097 Lumens (1024 lumens/foot)

36.9 Watts (9.2 watts/foot)

CCT: 3500K

CRI: 80

ITL LM79 Report 90629

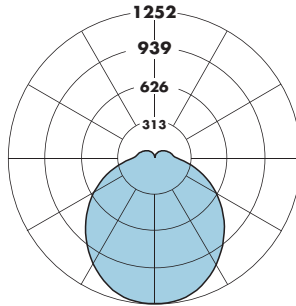

CANDELA DISTRIBUTION						
	0.0	22.5	45.0	67.5	90.0	Flux
0	1251	1251	1251	1251	1251	1251
5	1243	1244	1247	1249	1250	119
15	1187	1188	1204	1210	1210	338
25	1077	1082	1106	1116	1117	507
35	924	940	973	986	987	603
45	752	779	818	836	841	623
55	569	604	651	677	683	572
65	382	425	477	510	520	462
75	199	249	307	345	358	312
85	50	104	165	206	219	170
90	10	61	120	160	173	
95	8	57	111	147	159	109
105	6	48	96	127	138	91
115	5	39	82	109	118	72
125	4	30	66	89	97	53
135	3	21	50	69	76	35
145	2	12	32	50	55	19
155	1	5	17	30	34	8
165	1	1	6	11	15	2
175	0	0	0	0	0	0
180	0	0	0	0	0	0

Total Light Output, 3500K, 80 CRI (Lumens) - 4' Luminaire			
S*	B*	H*	V**
1677	2108	3187	4097

Lumen Adjustment Factors - 80 CRI	
3000K	0.985
3500K	1.000
4000K	1.032

Light Output, 3500K, 80 CRI (Lumens Per Foot)			
S*	B*	H*	V**
419	527	797	1024

Lumen Adjustment Factors - 90 CRI	
3000K	0.746
3500K	0.760
4000K	0.789

Power (Watts Per Foot)			
S*	B*	H*	V**
3.6	4.6	7.1	9.2

Apply a lumen adjustment factor to calculate lumens for the desired CCT and CRI.

Efficacy, 3500K, 80 CRI (Lumens Per Watt)			
S*	B*	H*	V**
116	115	113	111

### SAMPLE LUMEN ADJUSTMENT CALCULATION

High Output (H), 4000K, 90 CRI  
Lumen Adjustment Factor = 0.789

$$\text{Total Light Output} = 3187 \text{ lm} \times 0.789 = 2515 \text{ lm}$$

$$\text{Total Light Output per Foot} = 797 \text{ lm/ft} \times 0.789 = 629 \text{ lm/ft}$$

$$\text{watts/foot} = 7.1 \text{ W/ft}$$

$$\text{Efficacy} = \frac{629 \frac{\text{lm}}{\text{ft}}}{7.1 \frac{\text{W}}{\text{ft}}} = 89 \text{ lm/W}$$

S - Standard Output, B - Boosted Standard Output, H - High Output, V - Very High Output

\* Family Correlation based on 4' luminaire 3500K Very High Output (V) test - 120V.

\*\* Based on ITL report: 90629

# FINELITE

## High Performance 4" Aperture (HP-4) - Surface Mount

### PHOTOMETRY

#### DOWNLIGHT: REGRESSED DIFFUSER

HP-4-D-RG-V-835

Very High Output - 4' Luminaire

Efficacy: 94 Lumens per watt

Total luminaire output: 3477 Lumens (869 lumens/foot)  
37 Watts (9.3 watts/foot)

Peak Candela Value: 1436 @ 0°

CCT: 3500K

ITL LM79 Report 90353

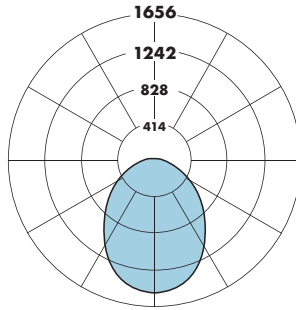

CANDELA DISTRIBUTION						
	0.0	22.5	45.0	67.5	90.0	Flux
0	1507	1507	1507	1507	1507	1507
5	1497	1496	1496	1497	1498	142
15	1429	1419	1418	1410	1400	398
25	1293	1276	1259	1237	1227	579
35	1109	1087	1053	1020	1003	659
45	902	871	824	780	764	638
55	682	645	588	541	525	532
65	457	418	358	313	299	364
75	244	203	151	120	115	178
85	60	36	33	32	31	43
90	0	0	0	0	0	0

Total Light Output, 3500K, 80 CRI (Lumens) - 4' Luminaire			
S*	B*	H*	V**
1423	1789	2704	3477

Light Output, 3500K, 80 CRI (Lumens Per Foot)			
S*	B*	H*	V**
356	447	676	869

Power (Watts Per Foot)			
S*	B*	H*	V**
3.6	4.6	7.1	9.3

Efficacy, 3500K, 80 CRI (Lumens Per Watt)			
S*	B*	H*	V**
98	97	95	94

S - Standard Output, B - Boosted Standard Output, H - High Output, V - Very High Output

\* Family Correlation based on 4' luminaire 3500K Very High Output (V) test - 120V.

\*\* Based on ITL report: 90353

Lumen Adjustment Factors - 80 CRI	
3000K	0.985
3500K	1.000
4000K	1.032

Lumen Adjustment Factors - 90 CRI	
3000K	0.746
3500K	0.760
4000K	0.789

Apply a lumen adjustment factor to calculate lumens for the desired CCT and CRI.

### SAMPLE LUMEN ADJUSTMENT CALCULATION

High Output (H), 4000K, 90 CRI

Lumen Adjustment Factor = 0.789

$$\text{Total Light Output} = 2704 \text{ lm} \times 0.789 = 2133 \text{ lm}$$

$$\text{Total Light Output per Foot} = 676 \text{ lm/ft} \times 0.789 = 533 \text{ lm/ft}$$

$$\text{watts/foot} = 7.1 \text{ W/ft}$$

$$\text{Efficacy} = \frac{533 \frac{\text{lm}}{\text{ft}}}{7.1 \frac{\text{W}}{\text{ft}}} = 75 \text{ lm/W}$$

# FINELITE

## High Performance 4" Aperture (HP-4) - Surface Mount

### PHOTOMETRY

DOWNLIGHT: WHITE CROSS BLADE BAFFLE

HP-4-D-RG-V-835-WCB

Very High Output - 4' Luminaire

Efficacy: 81 lumens per watt

Total luminaire output: 3001 Lumens (750 lumens/foot)  
36.9 Watts (9.2 watts/foot)Peak

Candela Value: 1636 @ 0°

CCT: 3500K

ITL LM79 Report 90672

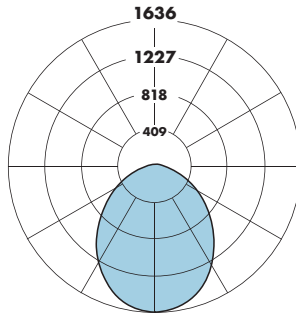

CANDELA DISTRIBUTION						
	0.0	22.5	45.0	67.5	90.0	Flux
0	1636	1636	1636	1636	1636	
5	1597	1601	1611	1623	1627	152
15	1385	1397	1449	1505	1533	408
25	1102	1121	1193	1286	1347	554
35	796	822	911	1028	1116	580
45	491	526	632	765	868	504
55	332	339	380	514	611	383
65	210	214	232	290	356	253
75	111	112	118	131	150	131
85	30	30	30	31	34	35
90	0	0	0	0	0	

Total Light Output, 3500K, 80 CRI (Lumens) - 4' Luminaire			
S*	B*	H*	V**
1228	1544	2334	3001

Light Output, 3500K, 80 CRI (Lumens Per Foot)			
S*	B*	H*	V**
307	386	584	750

Power (Watts Per Foot)			
S*	B*	H*	V**
3.6	4.6	7.1	9.2

Efficacy, 3500K, 80 CRI (Lumens Per Watt)			
S*	B*	H*	V**
85	84	82	81

S - Standard Output, B - Boosted Standard Output, H - High Output, V - Very High Output

\* Family Correlation based on 4' luminaire 3500K Very High Output (V) test - 120V.

\*\* Based on ITL report: 90672

Lumen Adjustment Factors - 80 CRI	
3000K	0.985
3500K	1.000
4000K	1.032

Lumen Adjustment Factors - 90 CRI	
3000K	0.746
3500K	0.760
4000K	0.789

Apply a lumen adjustment factor to calculate lumens for the desired CCT and CRI.

### SAMPLE LUMEN ADJUSTMENT CALCULATION

High Output (H), 4000K, 90 CRI

Lumen Adjustment Factor = 0.789

$$\begin{aligned} \text{Total Light Output} &= \\ 2334 \text{ lm} \times 0.789 &= 1842 \text{ lm} \end{aligned}$$

$$\begin{aligned} \text{Total Light Output per Foot} &= \\ 584 \text{ lm/ft} \times 0.789 &= 461 \text{ lm/ft} \end{aligned}$$

$$\text{watts/foot} = 7.1 \text{ W/ft}$$

$$\text{Efficacy} = \frac{461 \frac{\text{lm}}{\text{ft}}}{7.1 \frac{\text{W}}{\text{ft}}} = 65 \text{ lm/W}$$

# FINELITE

## High Performance 4" Aperture (HP-4) - Surface Mount

### SPECIFICATIONS

**CONSTRUCTION:** Precision-cut 6061-T6 extruded aluminum body. Internal joiner system, plug-together wiring, standard.

**ENDCAPS:** Flat diecast aluminum endcaps add 1/4" to each end of luminaire. Drop Down Lens Illuminated Endcap (**DE**) includes diffuse element to continue luminance of drop lens. Open Endcap (**OE**) is for use with the Hollowed Ellipse Louver (**LHE**); following the curve of the louver.

**MITERED CORNERS<sup>1</sup>:** Illuminated 90° corners in a single plane, available with Top Glow™, Flush uplight diffuser, and/or Flush downlight diffuser, Bottom Glow Diffuser, 1" Drop Down Lens, Regressed Diffuser, or White Cross Blade Baffle. Contact factory for custom angles. 90 degree corners not available with Hollowed Ellipse Louver (**LHE**) or Hex Louver (**LHC**).

**REFLECTORS:** Die-formed 20-gauge cold-rolled steel reflectors are finished in 96 LG high reflectance matte white powder coat paint.

**DOWNLIGHT OPTION:** 12' maximum diffuser length. Flush frost white snap-in diffuser standard, 73% transmissive, 99% diffusion. Internal secondary diffusers at corners ensure visually seamless, uniform, continuous illumination. Available with Flush (**F**), Bottom Glow (**BG**), 1" Drop Down Lens (**DL**), White Cross Blade Baffle (**WCB**), Hollowed Ellipse Louver (**LHE**), Hex Louver (**LHC**), and Regressed downlight diffusers (**RG**). 1" Drop Down Lens made of highly efficient acrylic. Available with a solid endcap or an endcap with a diffuse filler to continue the luminous aesthetic.

**LIGHT OUTPUT:** Four lumen packages available, Standard Output (**S**), Boosted Standard Output (**B**), High Output (**H**), and Very High Output (**V**). A separate chart summarizes lumen distribution and wattage. Light engines are replaceable.

**LUMEN MAINTENANCE:** 90% of initial light output (L90) at 100,000+ hours; 70% of initial light output (L70) at 200,000+ hours.

**DRIVER:** Replaceable 120V/277V Constant Current Reduction dimming driver standard. Can be wired dimming or non-dimming. 0-10V dimming controls with a range of 10%- 100%. Dimming to 1% available; consult factory. Driver is fully accessible from below the ceiling. Power Factor:  $\geq 0.9$ . Total Harmonic Distortion (THD):  $<20\%$ . Expected driver lifetime: 100,000 hours. Dali driver also available; Contact factory.

**LUTRON DRIVER OPTIONS:** **LUTES1** (Hi-lume 1% EcoSystem with Soft-On, Fade to Black dimming (LDE1 series)); **LUTES5** (5-Series 5% EcoSystem (LDE5 Series)), **LUT2W** (Hi-lume 1% 2-wire, 120V forward phase dimming (LTEA series)); Contact factory for availability of discontinued Lutron drivers, L3DA-3-wire and L3DA EcoSystem.

**ELECTRICAL:** Optional emergency to generator/inverter wiring, internal generator transfer switch, nightlight wiring, step-dimming driver, backup battery. Factory-choice low-profile backup battery available. 8' minimum fixture length for low profile battery pack. Bodine BSL722 battery pack also available; 4' minimum fixture length. Backup batteries deliver 1854 lumens. Half of a 4' section will be illuminated in emergency mode.

**INTEGRATED SENSORS:** Integrated PIR (Passive Infrared) occupancy or daylight sensors available with Flush, Bottom Glow, White Cross Blade Baffle, and Regressed downlight diffusers. Refer to Occupancy Sensor and Daylight Sensor tech sheets for more info.

**MOUNTING:** Lay-in ceiling types: caddy clip with 1/4 - 20 stud and nut. Drywall or concrete surfaces (walls or ceilings): 1/4 - 20 stud and nut (provided by others).

**FINISHES:** Finelite Signal White powder coat standard. Optional Adders: 185 RAL colors.

**FEED:** Standard with one 18-gauge/5-conductor single-circuit feed. 14-gauge feed used when fixture current exceeds 5 amps. Optional 6' flex conduit whips available.

**LENGTHS:** Any length, 2-foot minimum, in increments down to 1/16th-inch ( $\pm 1/32"$ ). 12-foot maximum section length. Hollowed Ellipse Louver (**LHE**), Hex Louver (**LHC**), and White Cross Blade Baffle (**WCB**) are available in 1' increments.

**LABELS:** Fixture and electrical components are ETL-listed conforming to UL 1598 in the U.S.A. and CAN/CSA C22.2 No. 250.0 in Canada. In accordance with NEC Code 410.130 (G), this luminaire contains an internal driver disconnect. Damp Location. Finelite products use electronic components that are RoHS compliant, and the mechanical components of the luminaire have been verified to not knowingly contain any restricted substances listed per RoHS Directive 2011/65/EU.

**WEIGHT:** 2.8 lb/ft.

**DLC QUALIFIED:** Configurations of this product are listed on the DLC Qualified Products List (QPL). Contact factory for Regressed luminaire qualification. [www.designlights.org/search](http://www.designlights.org/search)

**WARRANTY:** 10-year performance-based warranty on all standard components. Optional accessories such as emergency battery packs are covered by their individual manufacturer warranties.

### Surface Mount Options:

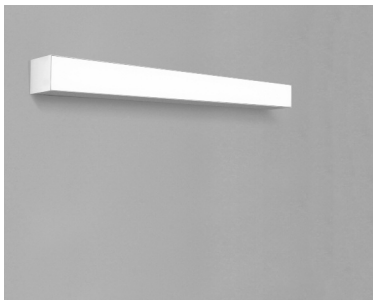

Horizontal Surface Mount

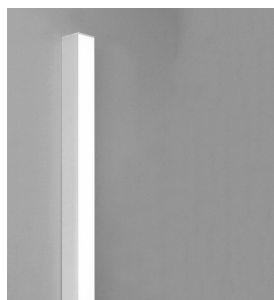

Vertical Surface Mount



Ceiling Surface Mount

<sup>1</sup> White Cross Blade Baffle (WCB) is not available with custom angles. Available in 90 degrees only