

4CRDI LED

4" Direct/Indirect Cylinder – Round

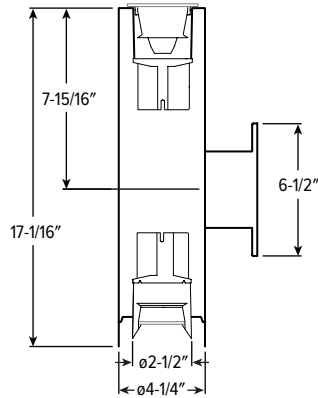

CATALOG #: _____

TYPE: _____

PROJECT: _____

GET A QUOTE >

FEATURES

- Slim profile for unobtrusive illumination
- Smoothly accent walls and eliminate dark ceilings with direct and indirect lighting
- Parallel the performance and style of the Williams downlight collection
- Precision illumination with 8° narrow spot to 70° wide optics
- Complement the architectural elements of any space with a multitude of housing and trim finishes

SPECIFICATIONS

- **HOUSING** – Extruded aluminum with die-cast aluminum accent ring.
- **FINISH** – Polyester powder coat bonded to phosphate-free, multi-stage pretreated metal. All parts painted after fabrication to facilitate installation, increase efficiency, and inhibit corrosion.
- **OPEN REFLECTOR** – Low-iridescent anodized aluminum. Clear semi-specular finish standard.
- **LENSED TRIM** – Die-cast aluminum frame with micro-prismatic, tempered glass lens.
- **ELECTRICAL** – High-performance Class 2 C.O.B. LED array. Modular quick-connect plug for easy field-connection of LED light assembly to driver. Reported L70>55,000 hours. Reported L90 = 49,000 hours. Estimated L70 = 179,000 hours.
- **MOUNTING** – Wall mount. Indoor applications only. Max weight 5-1/2 lbs.
- **LISTINGS** –
 - cCSAus conforms to UL STD 1598 and UL STD 8750. Certified to CAN/CSA STD C22.2 No. 250.0. Suitable for damp locations.
- **WARRANTY** – 5-year limited warranty, see hew.com/warranty.

ORDERING EXAMPLE: 4CRDI - L12/835U/L12/835D - WHT - DIM - UNV - LW/LM - CS - TRIM OPTIONS - WM MOUNT.

HOUSING

SERIES	LUMEN PACKAGE (Example: L12/835U/L9/835D)	HOUSING FINISH ^[1]	CONTROL ^[2]	VOLTAGE
4CRDI	Specify lumen packages: U for Uplight and D for Downlight	ALUM Silver sparkle aluminum	DIM Entire fixture switches and dims together	UNV 120-277V
	LUMENS ^[3] CRI CCT U OR D	BLK Textured black		347 347V
	L9 900lm 8 80 27 2700K U Uplight	BRZ Textured bronze		
	L12 1,200lm 9 90 ^[4] 30 3000K D Downlight	NKL Textured nickel		
	L15 1,500lm 35 3500K	SLV Textured silver		
	L20 2,000lm 40 4000K	WHT Textured white		
				50 5000K

TRIM

TRIM TYPE AND DISTRIBUTION ^[5]
(Example Uplight/Downlight: LW/LM)

TRIM TYPE	DISTRIBUTION
Uplight	Uplight
O Open reflector with clear glass shield ^[10]	W 70° Wide
L Flush lens ^[11]	M 40° Medium
	N 15° Narrow ^[12]
	S 8° Narrow spot ^[13]
Downlight	Downlight
O Open reflector	W 70° Wide
L Flush lens	M 40° Medium
R Regressed lens	N 15° Narrow
	S 8° Narrow spot ^[14]

REFLECTOR FINISH ^[6]

Downlight Open Trim Types
CS Clear semi-specular anodize
SG Satin-glow anodize
GD Gold anodize
CG Champagne gold anodize
PW Pewter anodize
SPC Clear specular anodize
RG Rose gold anodize
WH White texture powder coat
BL Black texture powder coat
Downlight Lens Trim Types
CS Clear semi-specular powder coat
WH White texture powder coat
BL Black texture powder coat
BZ Bronze texture powder coat
NK Nickel texture powder coat
SV Silver texture powder coat
AL Silver sparkle aluminum

TRIM OPTIONS

AD Diffuse acrylic lens ^[7]
PD Diffuse 1/8" polycarbonate lens ^[8]
TD Diffuse polycarbonate lens media at top of open reflector ^[9]

MOUNTING

MOUNTING TYPE ^[15]

WM Wall mount

GET A QUOTE >

NOTES

- See page 4 for HOUSING FINISH DETAILS.
- See page 3 for ADDITIONAL CONTROL OPTIONS.
- Lumen output based on O trim type, W distribution and CS finish, 3500K/80CRI. Actual lumens may vary +/-5%, see page 2 for FIXTURE PERFORMANCE DATA.
- Extended lead times may apply. Consult factory for availability.
- Beam angle based on O Trim Type and CS Reflector Finish. Trim Type affects beam angle. See page 2 for FIXTURE PERFORMANCE DATA.
- Specified for Downlight Trim Type only. See page 4 for REFLECTOR FINISH DETAILS.
- Not available with O Trim Type. Downlight only. W distribution only.
- Not available with O Trim Type. Downlight only. W distribution only.
- O Trim Type only. Downlight only.
- CS Reflector Finish standard. Other colors available, consult factory.
- Trim finish matches Housing Finish. Other colors available, consult factory.
- O Trim Type only.
- Not available with L20 lumen package, L Trim Type, or 950 CRI/CCT.
- Not available with L20 lumen package or 950 CRI/CCT.
- See page 3 for MOUNTING DETAILS.



4CRDI^{LED} 4" Direct/Indirect Cylinder – Round

FIXTURE PERFORMANCE DATA

DIST.	WATTAGE	DOWNLIGHT						UPLIGHT					
		OPEN REFLECTOR		FLUSH LENS		REGRESSED LENS		WATTAGE	OPEN REFLECTOR		FLUSH LENS		
		DELIVERED LUMENS	EFFICACY (lm/W)	DELIVERED LUMENS	EFFICACY (lm/W)	DELIVERED LUMENS	EFFICACY (lm/W)		DELIVERED LUMENS	EFFICACY (lm/W)	DELIVERED LUMENS	EFFICACY (lm/W)	
L9	W	10.7	929	87	973	91	963	90	10.6	760	72	1019	96
	M	10.7	898	84	958	90	917	86	10.6	734	69	1004	95
	N	10.7	799	75	950	89	927	87	10.6	653	62	–	–
	S	14.1	807	57	1115	79	1075	76	14.0	660	47	–	–
L12	W	14.3	1267	89	1327	93	1313	92	14.2	1036	73	1390	98
	M	14.3	1224	86	1307	91	1250	87	14.2	1001	70	1369	96
	N	14.3	1000	70	1296	91	1264	88	14.2	818	58	–	–
	S	20.4	1071	53	1480	73	1427	70	20.2	876	43	–	–
L15	W	17.7	1571	89	1645	93	1628	92	17.5	1285	73	1723	98
	M	17.7	1518	86	1620	92	1550	88	17.5	1241	71	1697	97
	N	17.7	1240	70	1607	91	1567	89	17.5	1014	58	–	–
	S	26.7	1326	50	1832	69	1767	66	26.5	1084	41	–	–
L20	W	23.4	1999	85	2160	92	2138	91	23.2	1687	73	2263	98
	M	23.4	1931	83	2127	91	2035	87	23.2	1630	70	2228	96
	N	23.4	1578	67	2110	90	2058	88	23.2	1332	57	–	–
	S	–	–	–	–	–	–	–	–	–	–	–	–

- Photometrics tested in accordance with IESNA LM-79. Results shown are based on 25°C ambient temperature.
- Wattage shown is based on 120V input.
- Results based on 3500K/80CRI and CS (O Trim Type) or WH (L and R Trim Types) Reflector Finish. Actual lumens may vary +/-5%.
- Wattage is for downlight or uplight components. Add wattages together for selected lumen packages to find total fixture wattage.
- Use multiplier tables to calculate additional options.

MULTIPLIER TABLES

	COLOR TEMPERATURE	
	CCT	CONVERSION FACTOR
80 CRI	2700K	0.92
	3000K	0.98
	3500K	1.00
	4000K	1.01
	5000K	1.02
90 CRI	2700K	0.76
	3000K	0.79
	3500K	0.82
	4000K	0.84
	5000K	0.88

	REFLECTOR FINISH	
	CATALOG NUMBER	CONVERSION FACTOR
O TRIM	CS	1.00
	SG ⁽¹⁾	0.92
	GD	0.93
	CG	0.96
	PW	0.86
	SPC	1.02
	RG	0.88
	WH ⁽¹⁾	0.89
	BL ⁽¹⁾	0.47
	R TRIM	WH
CS ⁽¹⁾		0.98
BL ⁽¹⁾		0.79
BZ ⁽¹⁾		0.76
NK ⁽¹⁾		0.81
SV ⁽¹⁾		0.81
AL ⁽¹⁾		0.86

TRIM OPTIONS	
CATALOG NUMBER	CONVERSION FACTOR
AD	0.85
PD	0.85
TD	0.67

¹ Distribution will also be affected, consult factory.

BEAM ANGLE

	TRIM TYPE		
	OPEN	FLUSH	REGRESSED
W	70°	50°	55°
M	40°	30°	30°
N	15°	20°	20°
S	8°	14°	14°

PHOTOMETRY

4CRDI-L12/835U/L12/835D-WHT-DIM1-UNV-OW/OW-CS-WM Total Luminaire Output: 2228 lumens; 28.5 Watts | Efficacy: 78 lm/W | 80 CRI; 3500K CCT

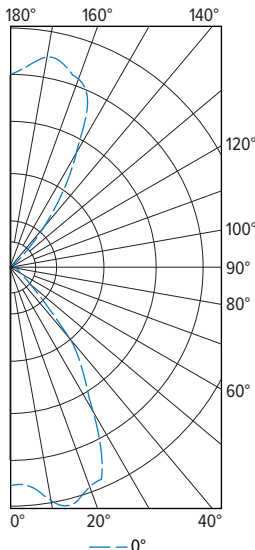

CANDLEPOWER DISTRIBUTION	VERTICAL ANGLE	HORIZONTAL ANGLE	ZONAL LUMENS
		0°	
	0	948	
	5	959	95
	15	1059	295
	25	917	406
	35	514	306
	45	72	77
	55	19	18
	65	6	7
	75	3	3
	85	2	2
	90	2	
	95	3	3
	105	6	6
	115	13	13
	125	30	28
	135	77	70
	145	370	227
	155	773	339
	165	883	249
	175	867	84
	180	826	

LUMEN SUMMARY	ZONE	LUMENS	% FIXTURE
	0 - 30	796	36
	0 - 40	1102	49
	0 - 60	1196	54
	0 - 90	1208	54
	90 - 120	23	1
	90 - 150	347	16
	90 - 180	1020	46
	0 - 180	2228	100



4CRDI LED

4" Direct/Indirect Cylinder – Round

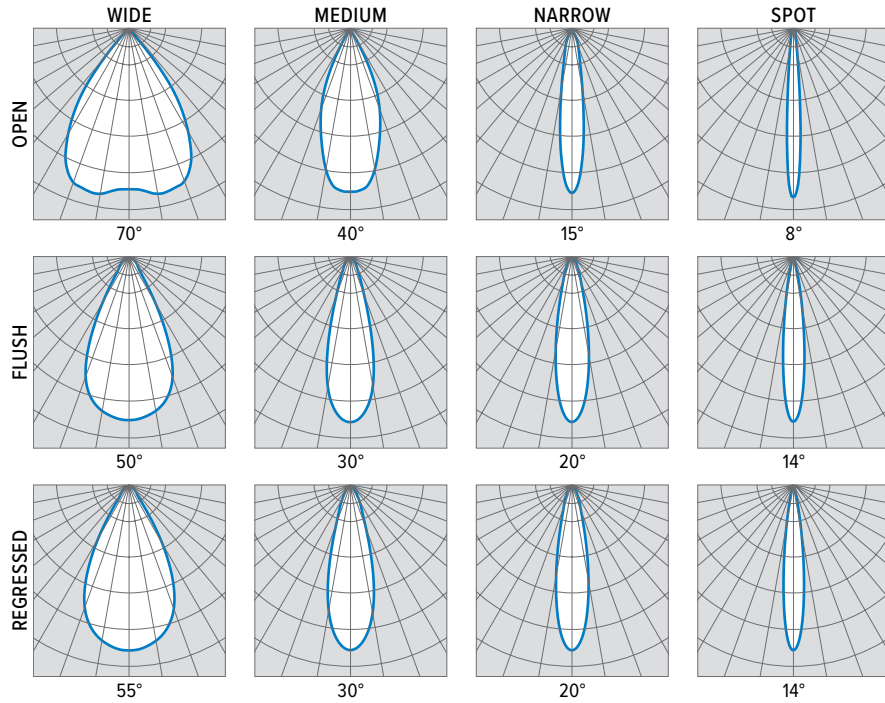

ADDITIONAL CONTROL OPTIONS

CATALOG NUMBER	DESCRIPTION
DIM	Dimming driver prewired for 0-10V low voltage applications; entire fixture switches and dims together
DIMU/DIMD	Dimming driver prewired for 0-10V low voltage applications; up and down portions switch and dim separately
DIM1	1% dimming driver prewired for 0-10V low voltage applications
DIM1U/DIM1D	1% dimming driver prewired for 0-10V low voltage applications; up and down portions switch separately
DIM LINE	Line voltage dimming driver (TRIAC and ELV compatible, 120V only)
DIM LINEU/DIM LINED	Line voltage switching and line voltage dimming; up and down portions switch separately

TRIM TYPE DETAILS

DOWNLIGHT

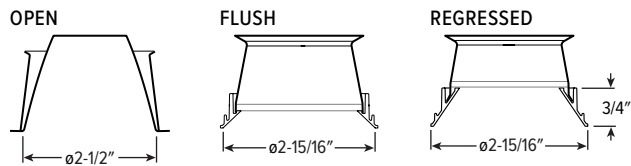

UPLIGHT

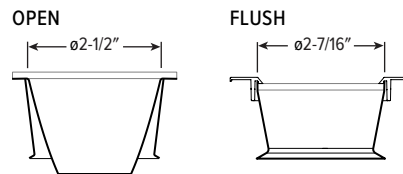

MOUNTING DETAILS

Mounts to 4" square J-box

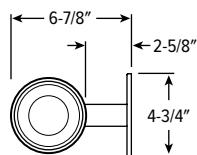

4CRDI^{LED} 4" Direct/Indirect Cylinder – Round

HOUSING FINISH DETAILS

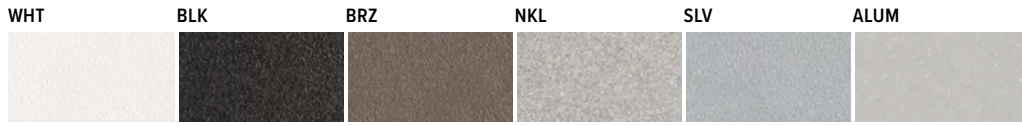

For custom color, please specify RAL code or a manufacturer code with description. All custom colors other than RAL require two sample swatches, minimum 1" square.

REFLECTOR FINISH DETAILS

SMOOTH FINISH

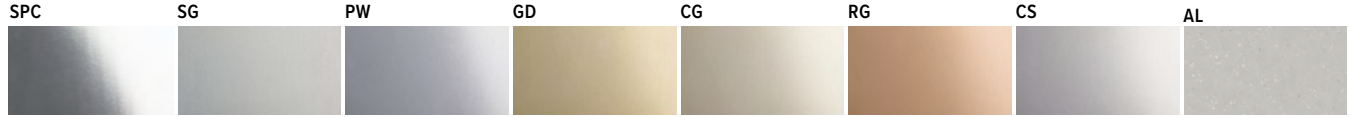

TEXTURED FINISH

