



# M4PS<sup>LED</sup> 4.5" MRI Shallow Plenum Downlight – Square

## FIXTURE PERFORMANCE DATA

	DISTRIBUTION	DELIVERED LUMENS	WATTAGE	EFFICACY (lm/W)
L10	W	1029	10.7	96.0
	M	1064	10.7	99.2
	N	1030	10.7	96.0
L15	W	1581	17.2	91.8
	M	1634	17.2	94.8
	N	1581	17.2	91.8
L20	W	2058	23.5	87.7
	M	2127	23.5	90.6
	N	2059	23.5	87.7
L30	W	3087	33.2	92.9
	M	3191	33.2	96.1
	N	3088	33.2	93.0
L40	W	4116	44.7	92.0
	M	4254	44.7	95.3
	N	4117	44.7	92.2

## MULTIPLIER TABLES

	COLOR TEMPERATURE		
	CCT	CONVERSION FACTOR	
80 CRI	2700K	0.92	
	3000K	0.98	
	3500K	1.00	
	4000K	1.01	
90 CRI	2700K	0.76	
	3000K	0.79	
	3500K	0.82	
	4000K	0.84	
		5000K	0.88

TRIM	
CATALOG NUMBER	CONVERSION FACTOR
AD	0.85
PD	0.85

- Photometrics tested in accordance with IESNA LM-79. Results shown are based on 25°C ambient temperature.
- Wattage shown is based on 120V input.
- Results based on 3500K, 80 CRI, actual lumens may vary +/-5%
- Use multiplier tables to calculate additional options.

## PHOTOMETRY

**M4PS-L40/835-DIM-UNV-LW-OF-WH** Total Luminaire Output: 4116 lumens; 44.7 Watts | Efficacy: 92.0 lm/W | 82.8 CRI; 3431K CCT

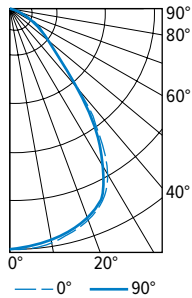

CANDLEPOWER DISTRIBUTION	VERTICAL ANGLE	HORIZONTAL ANGLE			ZONAL LUMENS
		0°	45°	90°	
	0	2316	2316	2316	
	5	2315	2303	2302	220
	15	2232	2221	2065	629
	25	2087	2092	2065	964
	35	1483	1764	1441	1016
	45	667	1028	644	620
	55	382	429	367	358
	65	208	205	203	205
	75	88	87	87	93
	85	13	12	10	12
	90	0	0	0	

LUMEN SUMMARY	ZONE	LUMENS	% FIXTURE
	0 - 30	1813	44
	0 - 40	2829	69
	0 - 60	3806	93
	0 - 90	4116	100
	0 - 180	4116	100

**M4PS-L40/835-DIM-UNV-LM-OF-WH** Total Luminaire Output: 4261 lumens; 44.7 Watts | Efficacy: 95.3 lm/W | 82.8 CRI; 3431K CCT

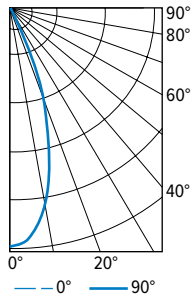

CANDLEPOWER DISTRIBUTION	VERTICAL ANGLE	HORIZONTAL ANGLE			ZONAL LUMENS
		0°	45°	90°	
	0	9143	9143	9143	
	5	8842	8817	8847	842
	15	6053	6054	6011	1714
	25	2094	2085	2088	967
	35	611	616	649	388
	45	226	244	238	182
	55	100	111	103	93
	65	48	52	52	50
	75	21	21	24	22
	85	1	3	2	2
	90	0	0	0	

LUMEN SUMMARY	ZONE	LUMENS	% FIXTURE
	0 - 30	3523	83
	0 - 40	3911	92
	0 - 60	4186	98
	0 - 90	4261	100
	0 - 180	4261	100

**M4PS-L40/835-DIM-UNV-LN-OF-WH** Total Luminaire Output: 4122 lumens; 44.7Watts | Efficacy: 92.2 lm/W | 82.8 CRI; 3431K CCT

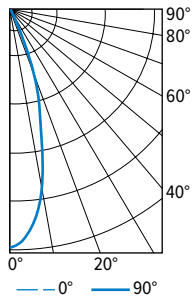

CANDLEPOWER DISTRIBUTION	VERTICAL ANGLE	HORIZONTAL ANGLE			ZONAL LUMENS
		0°	45°	90°	
	0	10746	10746	10746	
	5	10121	10033	10007	958
	15	5673	5741	5643	1618
	25	1750	1904	1859	850
	35	485	522	550	324
	45	208	221	228	170
	55	118	129	125	112
	65	57	67	63	63
	75	22	26	26	26
	85	0	2	3	2
	90	0	0	0	

LUMEN SUMMARY	ZONE	LUMENS	% FIXTURE
	0 - 30	3425	83
	0 - 40	3750	91
	0 - 60	4031	98
	0 - 90	4122	100
	0 - 180	4122	100



# M4PS<sup>LED</sup> 4.5" MRI Shallow Plenum Downlight – Square

## FLANGE TYPE DETAILS

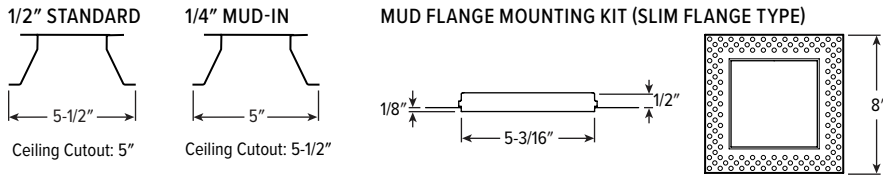

## REFLECTOR FINISH DETAILS

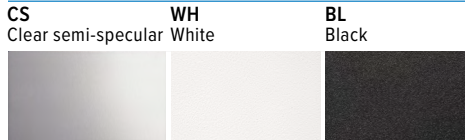

## MOUNTING TYPE DETAILS

### NEW CONSTRUCTION

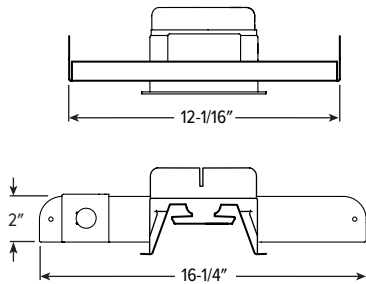

### IC-RATED

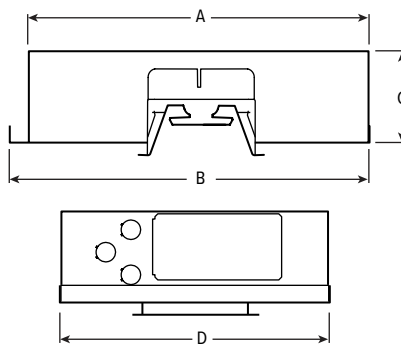

LUMENS	LENGTH			
	A	B	C	D
L10 - L20	15-3/16"	16"	4-1/8"	12-1/8"
L30	15-3/16"	16"	5-7/8"	12-1/8"

## ADDITIONAL DRIVER OPTIONS

Lumen restrictions apply: L30 max for DMX driver, L30 max for Lutron drivers. 347V may require stepdown transformer, see product builder at [hew.com/product-builder](http://hew.com/product-builder).

CATALOG NUMBER	DESCRIPTION
<b>DIM</b>	Dimming driver prewired for 0-10V low voltage applications
<b>DIM1</b>	1% dimming driver prewired for 0-10V low voltage applications
<b>DMX</b>	0.1% dimming driver for DMX controls
<b>LTE LINE</b>	Lutron Hi-lume 1% 2-wire dimming driver forward phase line voltage controls (120V only)
<b>LDE1</b>	Lutron Hi-lume 1% EcoSystem dimming LED driver
<b>LDE5</b>	Lutron 5-Series 5% EcoSystem dimming LED driver
<b>ELDO SOLOB</b>	EldoLED Solodrive, 0.1% dimming driver for 0-10V controls
<b>ELDO SOLOB DALI</b>	EldoLED Solodrive, 0.1% dimming driver for DALI controls
<b>ELDO ECO1</b>	EldoLED Ecodrive, 1% dimming driver for 0-10V controls
<b>ELDO ECO1 DALI</b>	EldoLED Ecodrive, 1% dimming driver for DALI controls

# M4PS<sup>LED</sup> 4.5" MRI Shallow Plenum Downlight – Square

## MOUNTING HARDWARE DETAILS

**F1M** Factory-installed 2-position fixed pan bracket, universal bar hanger included

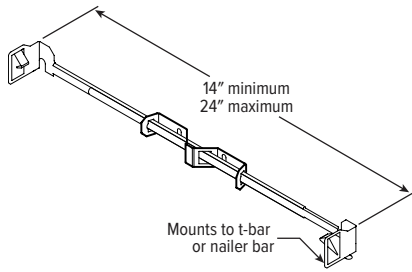

**BA1M** Adjustable butterfly pan bracket, aluminum, bar hanger not included (N Mounting Type only)

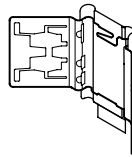

**CA1M** Adjustable caterpillar pan bracket, aluminum, universal bar hanger included (N Mounting Type only)

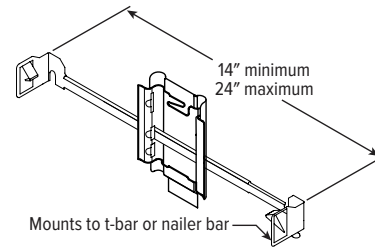

## REMOTE DRIVER ENCLOSURE DETAILS (ORDERED & SHIPPED SEPARATELY)

**REMOTE DRIVER ENCLOSURE FOR SINGLE FIXTURE**

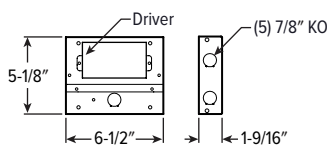

**REMOTE DRIVER ENCLOSURE FOR SINGLE FIXTURE WITH EM/12W**

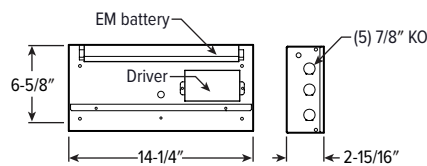

**REMOTE DRIVER ENCLOSURE FOR 2 - 8 FIXTURES**

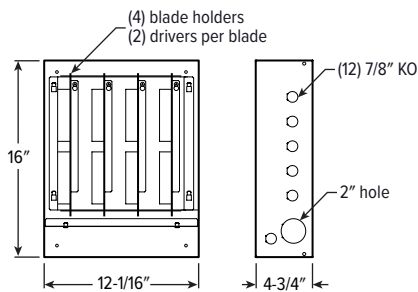

**REMOTE DRIVER ENCLOSURE FOR 9 - 12 FIXTURES**

