



LED-Ginger

Joan Gaspar

marset



LED-Ginger 60

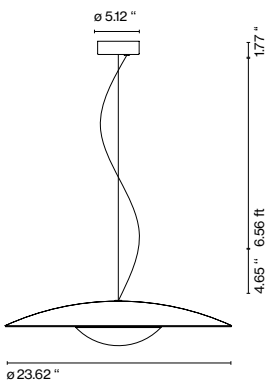

LED-Ginger 42

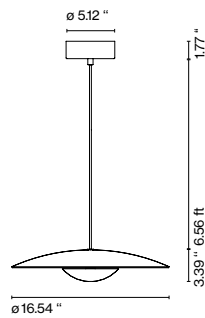

LED-Ginger 60

Light Source: LED SMD 700mA 22.4W 2700K
CRI90 2933lm
Luminaire: Only 120 VAC TRIAC 28W 1165lm
120 - 277 VAC 0-10V 28W 1165lm

LED-Ginger 42

Light Source: LED SMD 700mA 16.28W 2700K
CRI90 1873lm
Luminaire: 90 - 135 VAC TRIAC 21W 698lm
120 - 277 VAC 0-10V 21W 698lm

LED-Ginger 32

Light Source: LED SMD 700mA 8.2W 2700K
CRI90 913lm
Luminaire: 100 - 120 VAC TRIAC 14W 350lm
120 - 277 VAC 0-10V 14W 350lm

Pressed wood or brushed aluminum diffuser.
Injected and lacquered black metal matte aluminum dissipater.



Dry locations only

dimmable

- [Download](#) Assembly Instructions
- [Download](#) Photometric Data
- [Download](#) 2D
- [Download](#) 3D

LED-Ginger 32

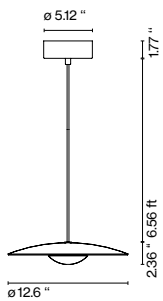

LED included

- Oak - White
- Wenge - White
- Brushed brass - Brushed brass
- Brushed brass - White
- Black - White

Black electrical cord

Range

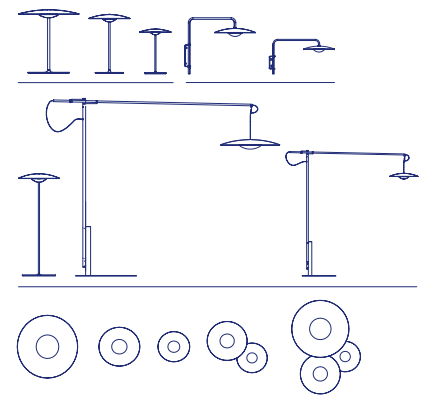

WARNING. California Proposition 65 Warning for California Consumers. This product can expose you to chemicals including wood dust and lead which are known to the State of California to cause cancer or birth defects or other reproductive harm. For more information go to www.P65Warnings.ca.gov

Watch the video
marsetusa@marset.com
www.marset.com

Wood is a great ally of cozy lighting. It is a material that is hard to mold, a challenge that the LED-Ginger collection neatly resolves. The combination of sheets of wood and paper pressed together under high pressure achieves a laminate that appears almost entirely flat.



LED-Ginger 20



LED-Ginger 20x3

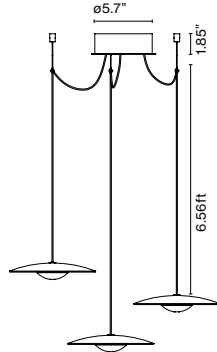

LED-Ginger 20x3: Canopy accessory

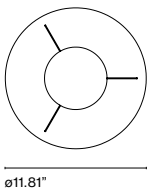

⚠ WARNING. California Proposition 65 Warning for California Consumers. This product can expose you to chemicals including wood dust and lead which are known to the State of California to cause cancer or birth defects or other reproductive harm. For more information go to www.P65Warnings.ca.gov

LED-Ginger 20

Light Source: LED SMD 350mA 4.05W
2700K CRI90 463lm
Luminaria: 90 - 264 VAC 6W 161lm
LED included

LED-Ginger 20x3

Light Source: LED SMD 350mA 12.15W
2700K CRI90 1389lm
Luminaire: Only 120 VAC TRIAC 16W 483lm
120 - 277 VAC 0-10V 16W 483lm

- Oak - Oak
- Wenge - Wenge
- Oak - White
- Wenge - White
- Brushed brass - Brushed brass
- Brushed brass - White
- Black - White

Black electrical cord

Watch the video

marsetusa@marset.com
www.marset.com

Pressed wood or brushed aluminum diffuser. Injected and lacquered black metal matte aluminum dissipater.

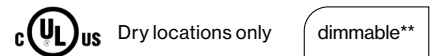

** Only Ginger 20x3 version

- [Download](#) Assembly Instructions
- [Download](#) Photometric Data
- [Download](#) 2D
- [Download](#) 3D

Range

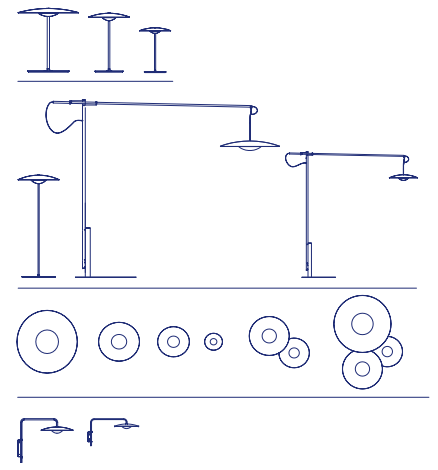

Wood is a great ally of cozy lighting. It is a material that is hard to mold, a challenge that the LED-Ginger collection neatly resolves. The combination of sheets of wood and paper pressed together under high pressure achieves a laminate that appears almost entirely flat.

For mounted canopy installation

Take into account the total power in watts, the power of the driver, and the wire entry points of the canopy. The total wattage of the selected lamps elements cannot exceed the max wattage of the canopy's driver. Therefore, you must choose your canopy/driver by the power required. Finally, the number of lamps installed in a single canopy cannot exceed the number of wire entry points of that canopy.

Canopy 20W/ Circular

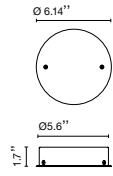

Canopy 50W/ Circular

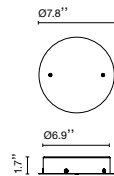

Canopy 50W/ Rectangular

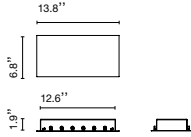

Canopy 50W/ Circular

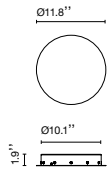

Canopy 100W/ Circular

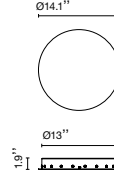

Hook accessory

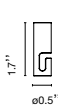

Power

Light source: LED SMD 24Vdc 5W 2700K CRI90 495lm
 Luminaire: (Power supply not included) 161lm

Wire entry points

Canopy 20W/ Circular	3
Canopy 50W/ Circular	5
Canopy 50W/ Rectangular	9
Canopy 50W/ Circular	9
Canopy 100W/ Circular	19

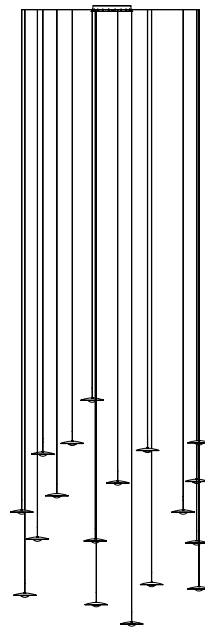

Black electrical cord

This system makes it possible to connect several suspension lamps into a single point of light, offering the absolute freedom to build with light. The Cluster accessory helps to illuminate large spaces or create compositions with the Dipping Light collection or the Ginger 20 model.

How LED-Ginger illuminates

