

Type: Quantity:

FIXTURE SPECIFICATIONS

INTENDED USE

Featuring a large center light source with an output of 2,400 Lumens, our pendant mount LED fixture with sound absorbing acoustic felt is ideal for libraries, office spaces waiting rooms and more where sound absorption is required. Our felt is made of 12mm thick polyethylene terephthalate is made with at least 55% recycled content.

FEATURES

Construction: Sound absorbing acoustic felt is made of polyethylene terephthalate and is 12mm or 0.47" thick. Contains at least 55% recycled content.

Lens: Acrylic

Pendant Mounting: 10' max pendant mount hanging kit

Color Temperature: 3000K Soft White

Lumen: 2,400 Lumen

Wattage: 27 Watts

CRI: 90+

LED Life: 50,000 hrs

Power Factor: >0.90

Listings: Made in the USA

Warranty: 1 Years carefree for parts & components (labor not included)

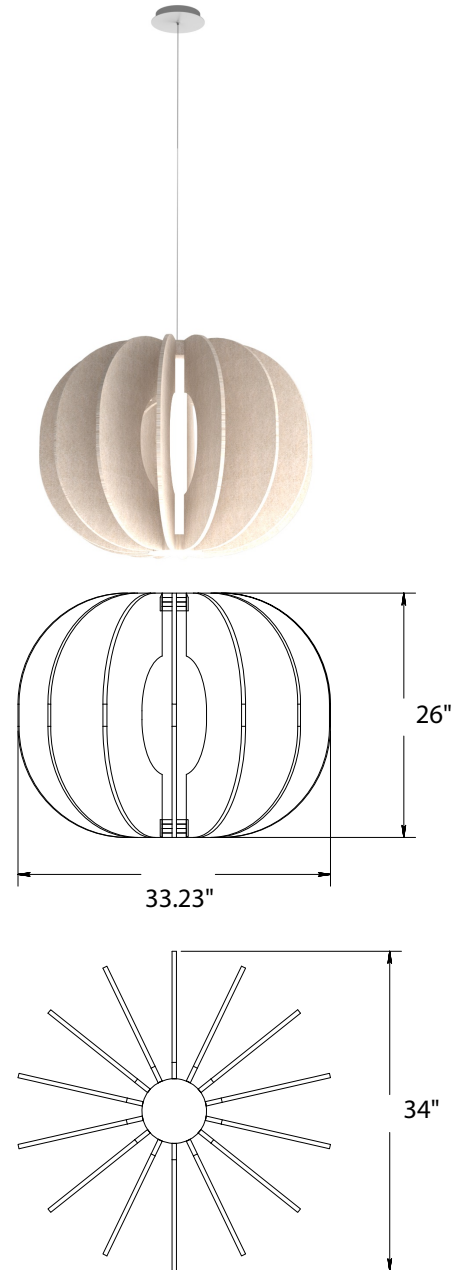

ORDERING INFORMATION Example: (11179-WH-010)

Model	Acoustic Felt Finish	Driver
11179	WH White	010 0-10V Dimming (120-277V) ^{Standard}
	LG Light Gray	
	DG Dark Gray	TRIELV Triac/ELV Dimming (120V)
	XX³ Custom colors	

¹ Refers to the top and bottom faces of acoustic felt
² Refers to the vertical side faces of acoustic felt
³ View page 2 for available custom color finishes

Sound Absorbing Material Options

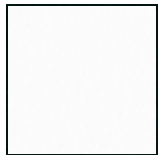

WH
White

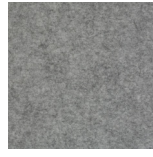

LG
Light Gray



PG
Pure Gray

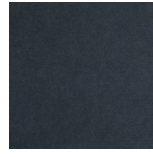

ST
Steel



DG
Dark Gray

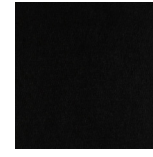

TB
True Black



GW
Grey Wash*



BRU
Brunette



IVR
Ivory



CRE
Cream



LAT
Latte



SMB
Smoky Beige



TAU
Taupe



SPE
Speckled Earth



TAN
Tangerine



ESP
Espresso



BIR
Big Red



LAV
Lava



BER
Berry



CAR
Caramel



MAR
Marigold



EMR
Emerald



SUO
Sunkist Orange



YEL
Yellow



GRA
Green Apple



AVO
Avocado



MOS
Moss



DRG
Dark Green

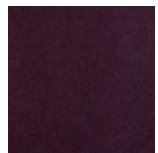

EGG
Eggplant



ARI
Arctic Ice



BL
Blue



AZU
Azure



DEN
Denim

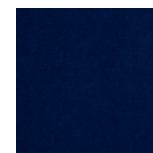

INB
Indigo Blue

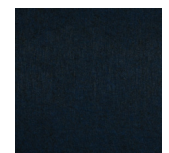

DEB
Deep Blue

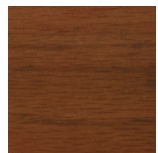

PMB
Pecan Medium
Brown*



BLB
Birch Light
Brown*



RS
Rich Soil*