

Project Name: \_\_\_\_\_ Type: \_\_\_\_\_ Quantity: \_\_\_\_\_

### INTENDED USE

Alcon Lighting's Outdoor Architectural Area & Site LED Post Light combines sleek design with high-performance illumination, seamlessly integrating into various environments. Its slim, lightweight housing enhances durability by optimizing heat management through convective cooling. Engineered with advanced LED technology, this fixture delivers exceptional efficiency, longevity, and uniform illumination, making it a versatile and energy-efficient solution for outdoor lighting applications.

### FEATURES

- Construction:** Die-cast aluminum
- Color Temperature:** 30/40/50K Selectable switch
- CRI:** 70+
- Voltage:** Universal 120-277 VAC or 347-480 VAC input voltage
- Driver:** 0-10V dimming driver down to 10%
- Power Adjustable:** 100%, 80%, 60%, 40%
- Power Factor:** ≥90%
- Operating Temperature:** -40°F to 113°F
- Life:** 100,000 Hours
- Listing:** UL wet location listed, DLC Premium
- Warranty:** 5 years carefree for parts & components (Labor not included).



11403-M (100W, 140W, 180W)



11403-L (300W, 400W)



### ORDERING INFORMATION Example:

Model	Size	Wattage	Finish	Mounting	Mounting Accessories <sup>3,4</sup>	Options <sup>4</sup>	
11403	M Medium	10 <sup>1</sup>	100W	B Dark Bronze	S Square Pole L Slipfitter W Wall Y Yoke A Adjustable Square	<b>4R</b> 4" Round Pole, 2-3/8" O.D. <b>4S</b> 4" Square Pole, 2-3/8" O.D. <b>5R</b> 5" Round Pole, 2-3/8" O.D. <b>5S</b> 5" Square Pole, 2-3/8" O.D. <b>A</b> Adjustable Pole Bracket <b>Y</b> Yoke Pole Bracket <b>W</b> Wall Square or Round pole, 2-3/8" <b>AK</b> Adjustable Arm Mount Kit <b>D90</b> Double 90° <b>D12</b> Double 120° <b>D18</b> Double 180° <b>T90</b> Triple 90° <b>T12</b> Triple 120° <b>Q90</b> Quad 90°	<b>GS</b> External Glare Shield <sup>3</sup> <b>GF</b> External Glare Full Visor <sup>3</sup> <b>PIR</b> PIR Sensor <b>P12</b> 120-277V PIR Sensor <b>M</b> Microwave Sensor <b>N</b> NEMA Photocell <b>BS</b> Back Light Control Shield
		14 <sup>1</sup>	140W				
	L Large	18 <sup>1</sup>	180W				
		30 <sup>2</sup>	300W				
		40 <sup>2</sup>	400W				
			W <sup>1</sup> White				

<sup>1</sup> Available in Medium size only.  
<sup>2</sup> Available in Large size only.  
<sup>3</sup> Accessories come in Dark Bronze finish.  
<sup>4</sup> See further information on pages 7 and 8.

## STRUCTURAL DESIGN

### Housing

The one-piece die-cast housing with corrosion-resistant coating protection and the modular design extend the life of the luminaire while making it easy to maintain.

### Photocell

Dusk to dawn controls can be utilized via optional twist-lock photocell.



### CCT & POWER Adjustable

Offer four selectable lumen output (40%/60%/80%/100%), and three selectable CCTs (30K/40K/50K)

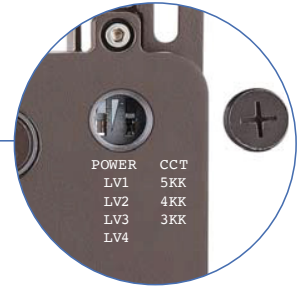

### Mounting

Optional for square, round pole mount, Slipfitter, wall mount, yoke mount. All mounting brackets are simple to operate, which can realize single operation and reduce labor costs.

### Occupancy Sensor

Optional occupancy sensor allows for security and energy saving.

## PHOTOMETRY

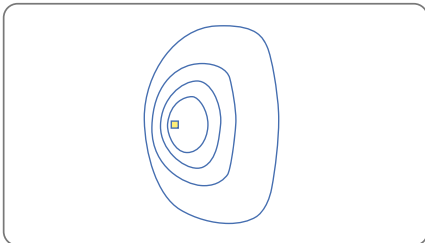

Produce an asymmetrical pattern that directs the majority of the light forward and equally on both sides of the luminaire. In a back-to-back configuration, it creates a rectangular pattern which can extend pole spacings.

## MULTIPLE CONFIGURATIONS

Wattage   Size	1	Double 90°   D90	Double 120°   D12	Double 180°   D18	Triple 90°   T90	Triple 120°   T12	Quad 90°   Q90
100/140/180W   Medium	0.3632	0.6849	0.8861	0.7264	1.0481	1.2078	1.0481
300/400W   Large	0.4758	0.8091	1.059	0.9516	1.2849	1.3923	1.2849

**PERFORMANCE DATA**

11403-M-10 (100W)									
SETTING	SYSTEM WATTS	DIST.TYPE	CRI	3000K		4000K		5000K	
				LUMENS	LPW	LUMENS	LPW	LUMENS	LPW
100%	100W	2	70	14500lm	145 lm/W	15800lm	158 lm/W	15000lm	150 lm/W
		3	70	14500lm	145 lm/W	15800lm	158 lm/W	15000lm	150 lm/W
		4	70	14500lm	145 lm/W	15800lm	158 lm/W	15000lm	150 lm/W
		5	70	15100lm	151 lm/W	16000lm	160 lm/W	15600lm	156 lm/W
80%	80W	2	70	12000lm	150 lm/W	13000lm	163 lm/W	12500lm	156 lm/W
		3	70	12000lm	150 lm/W	13000lm	163 lm/W	12500lm	156 lm/W
		4	70	12000lm	150 lm/W	13000lm	163 lm/W	12500lm	156 lm/W
		5	70	12500lm	156 lm/W	13300lm	166 lm/W	12800lm	160 lm/W
60%	60W	2	70	9300lm	155 lm/W	10000lm	167 lm/W	9600lm	160 lm/W
		3	70	9300lm	155 lm/W	10000lm	167 lm/W	9600lm	160 lm/W
		4	70	9300lm	155 lm/W	10000lm	167 lm/W	9600lm	160 lm/W
		5	70	9600lm	160 lm/W	10200lm	170 lm/W	9850lm	164 lm/W
40%	40W	2	70	6400lm	160 lm/W	6800lm	170 lm/W	6560lm	164 lm/W
		3	70	6400lm	160 lm/W	6800lm	170 lm/W	6560lm	164 lm/W
		4	70	6400lm	160 lm/W	6800lm	170 lm/W	6560lm	164 lm/W
		5	70	6560lm	164 lm/W	7000lm	175 lm/W	6700lm	168 lm/W

11403-M-14 (140W)									
SETTING	SYSTEM WATTS	DIST.TYPE	CRI	3000K		4000K		5000K	
				LUMENS	LPW	LUMENS	LPW	LUMENS	LPW
100%	140W	2	70	20000lm	147 lm/W	23000lm	164 lm/W	21000lm	150 lm/W
		3	70	20000lm	147 lm/W	23000lm	164 lm/W	21000lm	150 lm/W
		4	70	20000lm	147 lm/W	23000lm	164 lm/W	21000lm	150 lm/W
		5	70	21000lm	150 lm/W	23500lm	168 lm/W	21500lm	154 lm/W
80%	120W	2	70	18000lm	150 lm/W	20000lm	167 lm/W	18500lm	154 lm/W
		3	70	18000lm	150 lm/W	20000lm	167 lm/W	18500lm	154 lm/W
		4	70	18000lm	150 lm/W	20000lm	167 lm/W	18500lm	154 lm/W
		5	70	18500lm	154 lm/W	20500lm	171 lm/W	19000lm	158 lm/W
60%	90W	2	70	13800lm	153 lm/W	15200lm	169 lm/W	14200lm	158 lm/W
		3	70	13800lm	153 lm/W	15200lm	169 lm/W	14200lm	158 lm/W
		4	70	13800lm	153 lm/W	15200lm	169 lm/W	14200lm	158 lm/W
		5	70	14000lm	156 lm/W	15600lm	172 lm/W	14500lm	161 lm/W
40%	60W	2	70	9400lm	157 lm/W	10300lm	172 lm/W	9700lm	162 lm/W
		3	70	9400lm	157 lm/W	10300lm	172 lm/W	9700lm	162 lm/W
		4	70	9400lm	157 lm/W	10300lm	172 lm/W	9700lm	162 lm/W
		5	70	9600lm	160 lm/W	10500lm	175 lm/W	10000lm	167 lm/W

11403-M-18 (180W)									
SETTING	SYSTEM WATTS	DIST.TYPE	CRI	3000K		4000K		5000K	
				LUMENS	LPW	LUMENS	LPW	LUMENS	LPW
100%	180W	2	70	24800lm	138 lm/W	27000lm	150 lm/W	25200lm	140 lm/W
		3	70	24800lm	138 lm/W	27000lm	150 lm/W	25200lm	140 lm/W
		4	70	24800lm	138 lm/W	27000lm	150 lm/W	25200lm	140 lm/W
		5	70	25500lm	142 lm/W	28000lm	156 lm/W	26000lm	144 lm/W
80%	144W	2	70	20200lm	140 lm/W	22000lm	153 lm/W	20600lm	143 lm/W
		3	70	20200lm	140 lm/W	22000lm	153 lm/W	20600lm	143 lm/W
		4	70	20200lm	140 lm/W	22000lm	153 lm/W	20600lm	143 lm/W
		5	70	20800lm	144 lm/W	22800lm	158 lm/W	21000lm	146 lm/W
60%	108W	2	70	15300lm	142 lm/W	16800lm	156 lm/W	15700lm	145 lm/W
		3	70	15300lm	142 lm/W	16800lm	156 lm/W	15700lm	145 lm/W
		4	70	15300lm	142 lm/W	16800lm	156 lm/W	15700lm	145 lm/W
		5	70	15800lm	146 lm/W	17300lm	160 lm/W	16200lm	150 lm/W
40%	72W	2	70	10500lm	146 lm/W	11500lm	160 lm/W	10800lm	150 lm/W
		3	70	10500lm	146 lm/W	11500lm	160 lm/W	10800lm	150 lm/W
		4	70	10500lm	146 lm/W	11500lm	160 lm/W	10800lm	150 lm/W
		5	70	10800lm	150 lm/W	11800lm	164 lm/W	11000lm	153 lm/W

PERFORMANCE DATA

11403-L-30 (300W)									
SETTING	SYSTEM WATTS	DIST.TYPE	CRI	3000K		4000K		5000K	
				LUMENS	LPW	LUMENS	LPW	LUMENS	LPW
100%	300W	2	70	41000lm	137 lm/W	45000lm	150 lm/W	42000lm	140 lm/W
		3	70	41000lm	137 lm/W	45000lm	150 lm/W	42000lm	140 lm/W
		4	70	41000lm	137 lm/W	45000lm	150 lm/W	42000lm	140 lm/W
		5	70	42500lm	142 lm/W	46000lm	153 lm/W	43500lm	145 lm/W
80%	240W	2	70	33600lm	140 lm/W	37000lm	154 lm/W	34500lm	144 lm/W
		3	70	33600lm	140 lm/W	37000lm	154 lm/W	34500lm	144 lm/W
		4	70	33600lm	140 lm/W	37000lm	154 lm/W	34500lm	144 lm/W
		5	70	34500lm	144 lm/W	38000lm	158 lm/W	35500lm	148 lm/W
60%	180W	2	70	26000lm	144 lm/W	28600lm	159 lm/W	26600lm	148 lm/W
		3	70	26000lm	144 lm/W	28600lm	159 lm/W	26600lm	148 lm/W
		4	70	26000lm	144 lm/W	28600lm	159 lm/W	26600lm	148 lm/W
		5	70	26600lm	148 lm/W	29700lm	165 lm/W	27500lm	153 lm/W
40%	120W	2	70	18000lm	150 lm/W	20000lm	167 lm/W	18500lm	154 lm/W
		3	70	18000lm	150 lm/W	20000lm	167 lm/W	18500lm	154 lm/W
		4	70	18000lm	150 lm/W	20000lm	167 lm/W	18500lm	154 lm/W
		5	70	18500lm	154 lm/W	20800lm	173 lm/W	19000lm	158 lm/W

11403-L-40 (400W)							
SETTING	SYSTEM WATTS	DIST.TYPE	CRI	4000K		5000K	
				LUMENS	LPW	LUMENS	LPW
LV1	400W	2	70	60500lm	151 lm/W	60000lm	150 lm/W
		3	70	60500lm	151 lm/W	60000lm	150 lm/W
		4	70	60500lm	151 lm/W	60000lm	150 lm/W
		5	70	61000lm	153 lm/W	60800lm	152 lm/W
LV2	360W	2	70	56000lm	156 lm/W	55000lm	153 lm/W
		3	70	56000lm	156 lm/W	55000lm	153 lm/W
		4	70	56000lm	156 lm/W	55000lm	153 lm/W
		5	70	56500lm	157 lm/W	55500lm	154 lm/W
LV3	320W	2	70	51000lm	159 lm/W	50000lm	156 lm/W
		3	70	51000lm	159 lm/W	50000lm	156 lm/W
		4	70	51000lm	159 lm/W	50000lm	156 lm/W
		5	70	51500lm	161 lm/W	50500lm	159 lm/W
LV4	300W	2	70	47000lm	162 lm/W	46000lm	159 lm/W
		3	70	47000lm	162 lm/W	46000lm	159 lm/W
		4	70	47000lm	162 lm/W	46000lm	159 lm/W
		5	70	47500lm	164 lm/W	46500lm	160 lm/W



### BUG @5000K

SYSTEM WATTS	VOLTAGE	DIST.TYPE	B	U	G
100W	120-277V/347-480V	2	3	0	3
		3	3	0	3
		4	3	0	2
		5	4	0	2
		2	3	0	3
140W	120-277V/347-480V	3	3	0	3
		4	3	0	3
		5	4	0	2
		2	4	0	3
		3	3	0	3
180W	120-277V/347-480V	4	3	0	3
		5	4	0	2
		2	4	0	3
		3	3	0	3
		4	3	0	3
250W	120-277V/347-480V	5	5	0	3
		2	4	0	4
		3	4	0	4
		4	4	0	3
		5	5	0	3
300W	120-277V/347-480V	2	5	0	4
		3	4	0	4
		4	4	0	4
		5	5	0	4
		2	5	0	4
400W	120-277V/347-480V	3	5	0	5
		4	5	0	5
		5	5	0	4
		2	5	0	4
		3	5	0	5

### ELECTRICAL DATA

Number Of Drivers	Driver Current (mA)	Nominal Power (W)	INPUT VOLTAGE (V)	CURRENT (Amps)
1	850	100	120	0.83
		100	208	0.48
		100	240	0.42
	2520	100	277	0.36
		100	347	0.29
		100	480	0.21
1	1200	140	120	1.17
		140	208	0.67
		140	240	0.58
		140	277	0.51
		140	347	0.40
		140	480	0.29
1	960	180	120	1.50
		180	208	0.87
		180	240	0.75
		180	277	0.65
		180	347	0.52
		180	480	0.38
1	1200	250	120	2.08
		250	208	1.20
		250	240	1.04
		250	277	0.90
		250	347	0.72
		250	480	0.52
1	1500	300	120	2.50
		300	208	1.44
		300	240	1.25
		300	277	1.08
		300	347	0.86
		300	480	0.63
1	1460	400	120	3.33
		400	208	1.92
		400	240	1.67
		400	277	1.44
		400	347	1.15
		400	480	0.83

## MOUNTING OPTIONS



**Square Pole | S**  
 (4" and 5" Square and Round poles)  
 Standard versatile mounting arm is simple to install and can be used with existing poles for retrofit installations



**Slipfitter | L**  
 An optional cast aluminum mast arm adapter secures fixture head to nominal 2-3/8" O.D. horizontal steel tenon arm.



**Wall | W**  
 Wall Mount is easy to install for direct wall mounting with 1/2" conduit wiring or standard J-box mounting



**Yoke | Y**  
 Die-cast aluminum trunnion is easily adapted to many surfaces and allows easy fixture aiming angles.



**Adjustable Square | A**  
 Standard versatile mounting arm is simple to install and can be used with existing poles for retrofit installations.

## MOUNTING DIMENSIONS

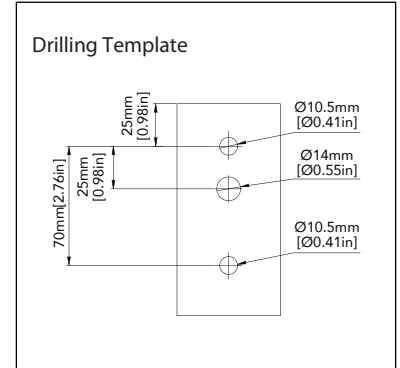
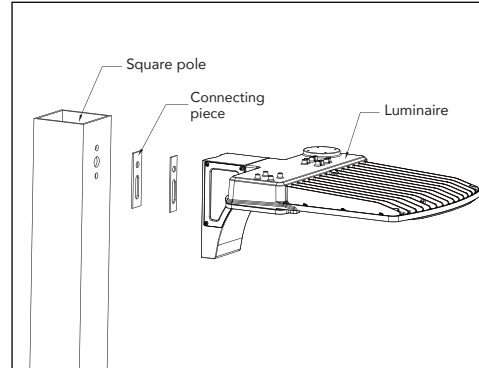
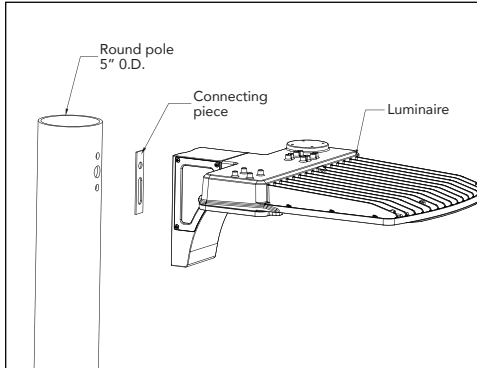

**100W/140W/180W (Adjustable Square Mount)**

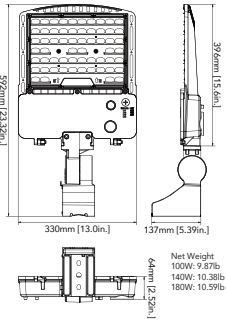

**100W/140W/180W (Slipfitter Mount)**

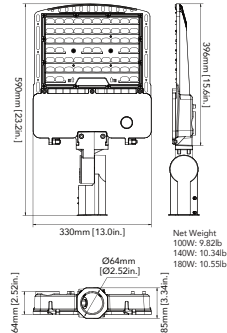

**100W/140W/180W (Wall Mount)**

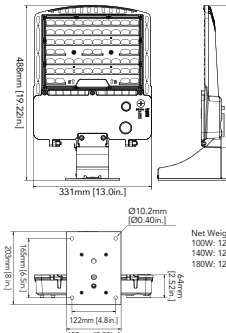

**100W/140W/180W (Pole Mount)**

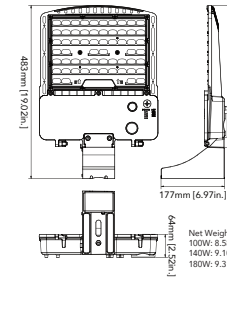

**100W/140W/180W (Yoke Mount)**

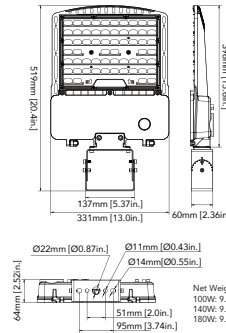

**300W/400W (Adjustable Square Mount)**

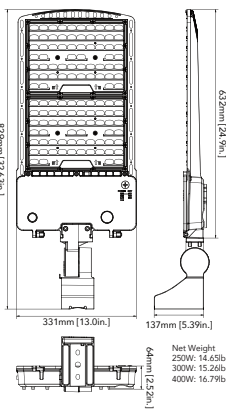

**300W/400W (Slipfitter Mount)**

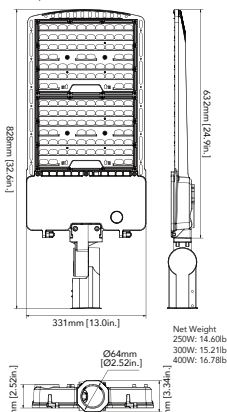

**300W/400W (Wall Mount)**

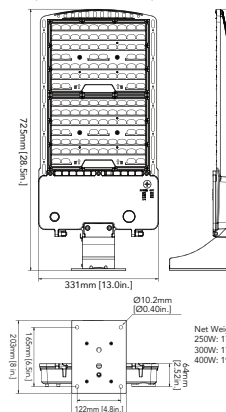



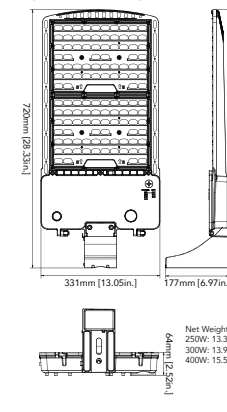



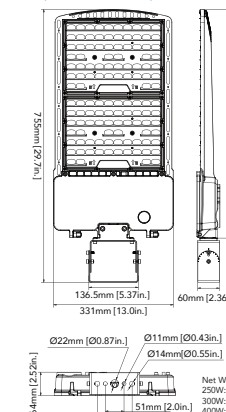

**300W/400W (Pole Mount)**



**300W/400W (Yoke Mount)**

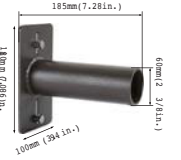

## MOUNTING ACCESSORIES

POLE BRACKET • For mounting one fixture on an existing pole			
	<p><b>4" Square Pole with 2-3/8" O.D. Tenon 4S</b></p> <p>For use with square, non-tapered steel and aluminum poles. Furnished with four 5/16" hex head stainless-steel bolts. Vertical tenon measures 2-3/8" O.D., and is made of steel tubing. Fixtures mounted to this bracket can be adjusted both vertically and horizontally.</p>		<p><b>4" Round Pole with 2-3/8" O.D. Tenon 4R</b></p> <p>For use with Round, non-tapered steel and aluminum poles. Furnished with three 3/8" hex head stainless-steel bolts. Vertical tenon measures 2-3/8" O.D., and is made of steel tubing. Fixtures mounted to this bracket can be adjusted both vertically and horizontally.</p>
	<p><b>5" Square Pole with 2-3/8" O.D. Tenon 5S</b></p> <p>For use with square, non-tapered steel and aluminum poles. Furnished with four 5/16" hex head stainless-steel bolts. Vertical tenon measures 2-3/8" O.D., and is made of steel tubing. Fixtures mounted to this bracket can be adjusted both vertically and horizontally.</p>		<p><b>5" Round Pole with 2-3/8" O.D. Tenon 5R</b></p> <p>For use with Round, non-tapered steel and aluminum poles. Furnished with three 3/8" hex head stainless-steel bolts. Vertical tenon measures 2-3/8" O.D., and is made of steel tubing. Fixtures mounted to this bracket can be adjusted both vertically and horizontally.</p>
	<p><b>Adjustable Pole Bracket A</b></p> <p>Durable brackets are engineered to provide versatile mounting options. These arms are made from rugged die-cast aluminum. They allow optimal positioning of the light fixture to maximize the lighting effectiveness vertically and horizontally.</p>		<p><b>Yoke Pole Bracket Y</b></p> <p>The 2-3/8" OD Tenon Mount Adaptor for Yoke Fixtures is designed to mount MESTER light fixtures that are equipped with a yoke mount onto a 2-3/8" OD tenon. It may be utilized with the Mester Flood Light Series of light fixtures.</p>
	<p><b>Wall Square or Round pole, 2-3/8" W</b></p> <p>This tenon bracket can be installed onto a wall, square pole, round pole. Provides wiring access and abuilt-in 2-3/8" O.D. tenon to mount a fixture with our adjustable slipfitter. Suggested 3/8" diameter bolts for mounting.</p>		<p><b>Adjustable Arm Mount Kit AK</b></p> <p>Adjustable pole mount kit, suitable for 4" &amp; 5" square or round pole</p>
WALL BRACKET • Attaches to any flat surface • Provides wiring access		Mid-Pole tenon Bracket	
	<p><b>90° Wall Mount Bracket with 2-3/8" O.D. Tenon Size</b></p> <p>The 90° wall mount bracket with 2-3/8" tenon attaches an Alcon Lighting floodlight to almost any surface; wall, roof, or wood pole. Provides wiring access and abuilt-in 2-3/8" O.D. tenon to mount a fixture with our adjustable slipfitter. Suggested 3/8" diameter bolts for mounting. Mounting holes are spaced 3-1/4" apart.</p>		<p><b>2-3/8" OD Horizontal Tenon Mid-Pole Bracket Size</b></p> <p>2-3/8" OD Horizontal Tenon Mid-Pole Bracket is designed to mount light fixture that is equipped with an adjustable slipfitter onto a 2-3/8" OD horizontal tenon</p>
Round External Mount Horizontal Tenon • To mount 2/3/4 fixtures on an existing pole			
	<p><b>Double 90° D90</b></p> <p>The Bracket is designed to mount over 2-3/8" (60mm) O.D. vertical tenon. Two fixtures can be mounted to the Round External Mount Horizontal Tenon and adjusted horizontally</p>		<p><b>Triple 120° T12</b></p> <p>The Bracket is designed to mount over 2-3/8" (60mm) O.D. vertical tenon. Three fixtures can be mounted to the Round External Mount Horizontal Tenon and adjusted horizontally</p>
	<p><b>Double 180° D18</b></p> <p>The Bracket is designed to mount over 2-3/8" (60mm) O.D. vertical tenon. Two fixtures can be mounted to the Round External Mount Horizontal Tenon and adjusted horizontally</p>		<p><b>Quad 90° Q90</b></p> <p>The Bracket is designed to mount over 2-3/8" (60mm) O.D. vertical tenon. Four fixtures can be mounted to the Round External Mount Horizontal Tenon and adjusted horizontally</p>
	<p><b>Triple 90° T90</b></p> <p>The Bracket is designed to mount over 2-3/8" (60mm) O.D. vertical tenon. Three fixtures can be mounted to the Round External Mount Horizontal Tenon and adjusted horizontally</p>		

## OPTIONS

							
<p><b>External Glare Shield   GS</b></p>		<p><b>External Glare Full Visor   GF</b></p>					
							
<p><b>PIR Sensor</b> <b>PIR</b> A PIR (Passive Infrared) sensor detects motion by sensing infrared heat emitted by people and objects.</p>		<p><b>Microwave Sensor</b> <b>M</b> Uses high-frequency electromagnetic waves to detect motion by sensing changes in wave reflections, enabling precise and reliable lighting control.</p>		<p><b>120-277V PIR Sensor</b> <b>P12</b> Operating within a wide voltage range, it detects infrared heat from moving objects to automatically switch lights on or off, enhancing energy efficiency and convenience.</p>		<p><b>NEMA Photocell</b> <b>N</b> The NEMA Photocell is a dusk-to-dawn sensor that automatically controls outdoor lighting based on ambient light levels.</p>	
							
<p><b>Back Light Control Shield</b> <b>BS</b></p>							



## COLOR TEMPERATURE GUIDE

2700K	3000K	3500K	4000K	5000K
<b>WARM WHITE</b>	<b>SOFT WHITE GLOW</b>	<b>NEUTRAL GLOW</b>	<b>COOL WHITE GLOW</b>	<b>DAYLIGHT GLOW</b>
friendly personal intimate	soft warm pleasing	sociable inviting non-threatening	neat clean efficient	bright cool alert
HOMES LIBRARIES RESTAURANTS	HOMES HOTEL ROOMS LOBBIES RETAIL STORES	EXECUTIVE OFFICES RECEPTION AREAS SUPERMARKETS	OFFICES CLASSROOMS MASS MERCHANTISERS SHOWROOMS	GRAPHICS INDUSTRY HOSPITALS GALLERIES BEAUTY SALONS
X	✓	✓	✓	X