



**RISK OF FIRE AND ELECTRICAL SHOCK. FIXTURE MUST BE INSTALLED BY A QUALIFIED ELECTRICIAN ONLY IN ACCORDANCE WITH NATIONAL, LOCAL BUILDING AND ELECTRICAL CODES. DISCONNECT POWER AT ELECTRICAL PANEL BEFORE SERVICING.**

### IMPORTANT

1. Read all instructions.
2. Install following national and local electrical code regulations.
3. This product is intended to be installed and serviced by a qualified, licensed electrician.
4. Do not install in wet locations, for dry and damp use only.
5. Turn off electrical power before installing or servicing the fixture in any way.
6. To reduce the risk of fire and overheating, ensure all connections are tight.
7. Under no circumstances can the lighting fixture be covered with a heat insulation gasket or similar materials.

### WIRING

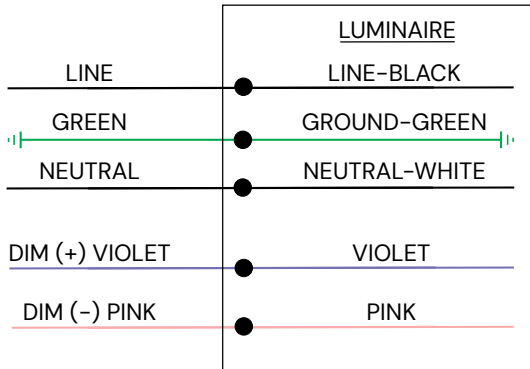

### STRUCTURE OF LAMP

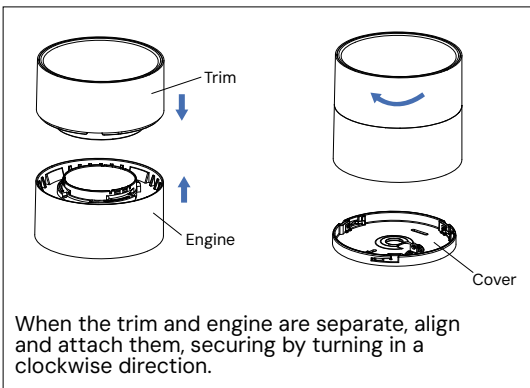

### INSTALLATION

#### Surface Mounting

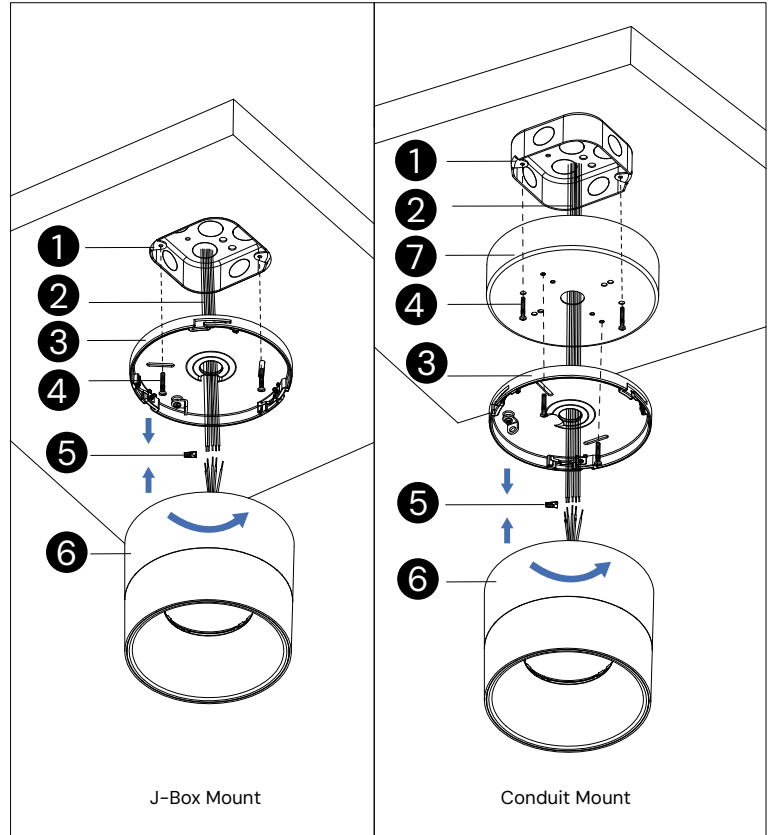

#### Part List

- 1 4" Octagon Junction Box (By Others)
- 2 Power Cord (By Others)
- 3 4", 6", 8" Cove
- 4 Screw KM4\*22
- 5 Wire Nut
- 6 4", 6", 8" Lamp
- 7 6" Canopy Power Feed



**RISK OF FIRE AND ELECTRICAL SHOCK. FIXTURE MUST BE INSTALLED BY A QUALIFIED ELECTRICIAN ONLY IN ACCORDANCE WITH NATIONAL, LOCAL BUILDING AND ELECTRICAL CODES. DISCONNECT POWER AT ELECTRICAL PANEL BEFORE SERVICING.**

### INSTALLATION

#### 4" Pendant With Cable

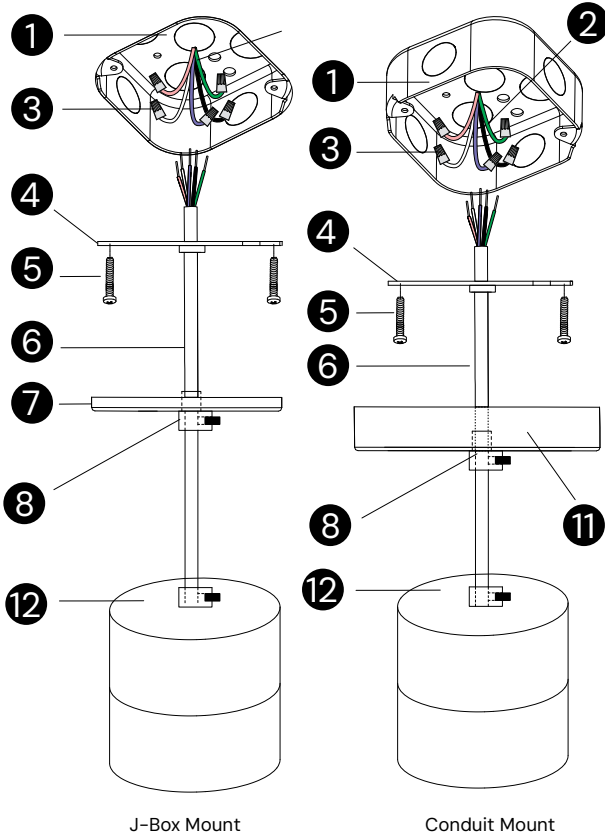

#### 6" And 8" Pendant With Cable

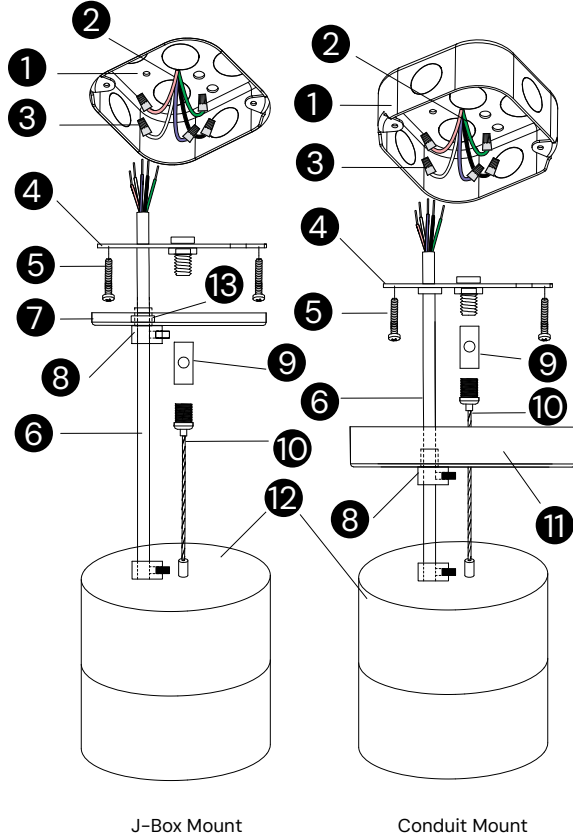

#### Part List

- ① 4" Octagon Junction Box (By Others)
- ② Power Cord (By Others)
- ③ Wire Nut
- ④ Junction Box Crossbar
- ⑤ Screw PM4\*22
- ⑥ Power Cord
- ⑦ 4" Canopy Power Feed
- ⑧ Cable Clip
- ⑨ Cable Holder
- ⑩ Aircraft Cable
- ⑪ 6" Canopy Power Feed
- ⑫ 4", 6", 8" Lamp
- ⑬ Screw nut

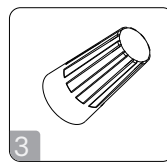

Wire Nut

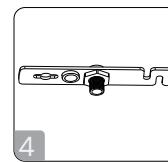

Junction Box Crossbar

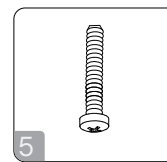

Screw PM4\*22

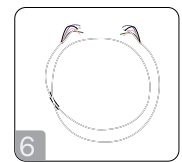

Power Cord

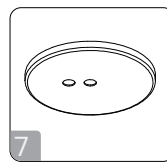

4" Canopy Power Feed

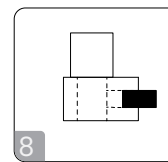

Cable Clip

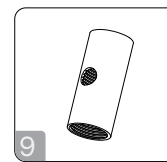

Cable Holder

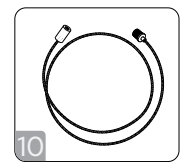

Aircraft Cable

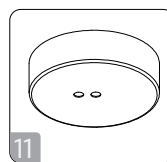

6" Canopy Power Feed

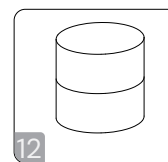

4", 6", 8" Lamp

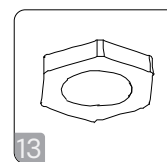

Screw Nut



**RISK OF FIRE AND ELECTRICAL SHOCK. FIXTURE MUST BE INSTALLED BY A QUALIFIED ELECTRICIAN ONLY IN ACCORDANCE WITH NATIONAL, LOCAL BUILDING AND ELECTRICAL CODES. DISCONNECT POWER AT ELECTRICAL PANEL BEFORE SERVICING.**

### INSTALLATION

#### Pendant With Stem

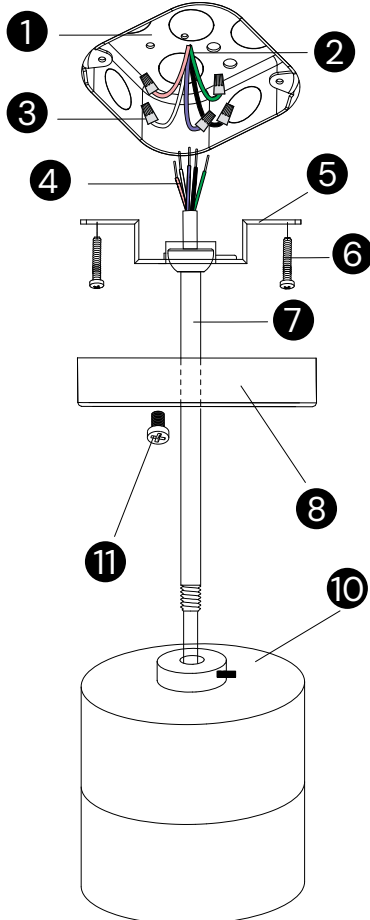

J-Box Mount

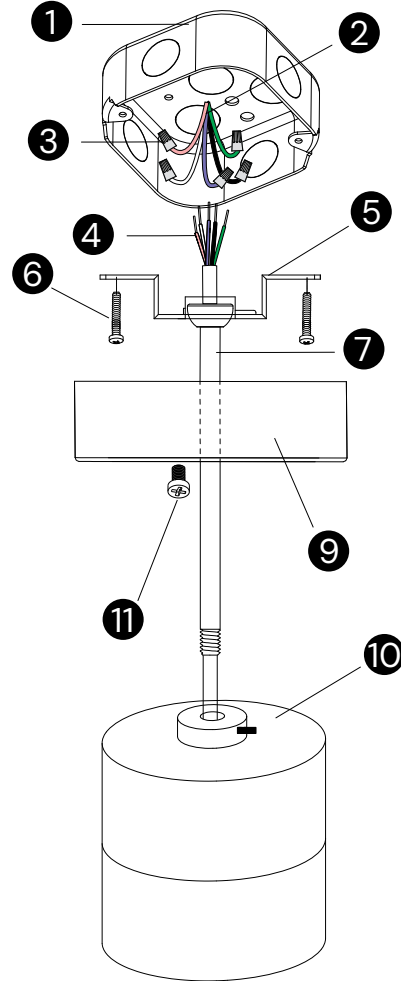

Conduit Mount

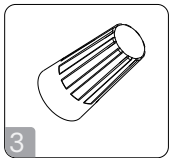

Wire Nut

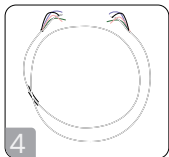

Power Cord

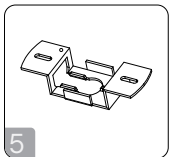

Junction Box Crossbar

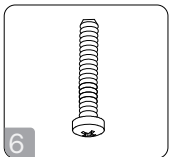

Screw PM4\*22

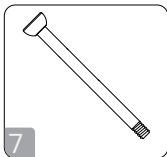

Stem Kits

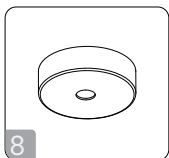

4" Stem Canopy Kits

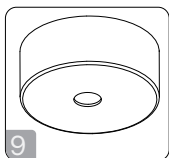

6" Stem Canopy Kits

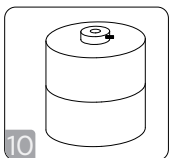

4", 6", 8" Lamp

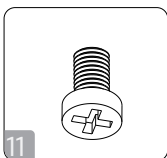

Screw PM3\*5

#### Part List

- 1 4" Octagon Junction Box (By Others)
- 2 Power Cord (By Others)
- 3 Wire Nut
- 4 Power Cord
- 5 Junction Box Crossbar
- 6 Screw PM4\*22
- 7 Stem Kits
- 8 4" Stem Canopy Kits
- 9 6" Stem Canopy Kits
- 10 4", 6", 8" Lamp
- 11 Screw PM3\*5