

FIXTURE SPECIFICATIONS

INTENDED USE

This slim linear LED light offers exceptional versatility. The modern extruded aluminum housing is available in standard lengths ranging from 2 to 8 feet, or continuous runs up to 40 feet for 120V and 100 feet for 277V. The pendant and wall mountings feature a 2-position DIP switch for customizable light distribution. You can choose from a range of finishes to match the design aesthetic of any office, museum, retail store, hotel, or restaurant.

FEATURES

- Construction:** Extruded aluminum housing with a powder coat finish
- Design:** For shapes other than single and continuous runs, the fixture will include pre-fabricated, non-illuminated corners
- Wattage:** 50/75/100% selectable switch
- Driver:** 0-10V dims to 10%
- Emergency Battery:** External 90 min. w/ test switch
- Color Temperature:** 30/35/40K selectable switch
- Light Distribution:** 25% up 75% down or 100% down via selectable switch
- Voltage:** 110-277V
- CRI:** 90+
- Life:** 50,000 Hours
- Warranty:** 5 Years carefree for parts & components (Labor not included)
- Listings:** cULus listed for damp locations

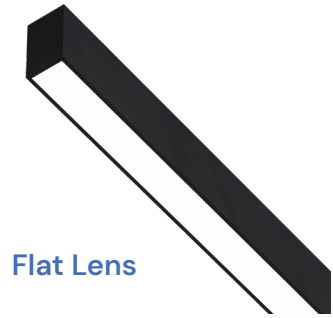

Flat Lens

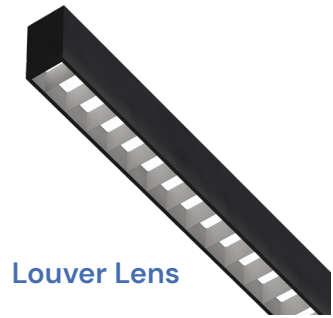

Louver Lens



Glow Lens



ORDERING INFORMATION Example:

Model	Mounting	Lens	Shape			Finish	Pendant Ceiling Type	Pendant Cord	Pendant Canopy Shape	Options
12100-12	P	Blank	Sx	Single Run	x = 2', 4' or 8'	W	Blank	Blank	Blank	EM8X
	Pendant	Flat ^{Standard}	CRx ¹	Continuous Run	x = Length	White	Not Required	Not Required	Not Required	8W External
	S	L	RCxx	Rectangle	xx = Width & Length	B	H ^{Standard}	AC5 ^{Standard}	R ^{Standard}	Emergency Battery
	Surface	Louver	SQx	Square	x = Length	Black	Hard /	5' Adjustable	S	EM25X
	W	G	HEx	Hexagon	x = Length		Drywall	Aircraft Cable	S	25W External
	Wall	Glow	Lxx	"L" Shape	xx = Leg 1, Leg 2		J-Box Mount	AC12	Square	Emergency Battery
			Xxx	Cross	xx = Leg 1, Leg 2		S9	12' Adjustable		OS ^{2,3}
			Vxx	"V" Shape	xx = Leg 1, Leg 2		Screw Slot	Aircraft Cable		Occupancy Sensor
			Yxxx	"Y" Shape	xxx = Leg 1, Leg 2, Leg 3		Grid 9/16"			
							S15			

¹ See Chart on Pg.6
² Only available with pendant mount
³ Only available with round canopy

Alcon Lighting 12100-12 Architectural LED Linear Direct/Indirect Light Fixture

LINE DRAWINGS & DIMENSIONS

2 Feet

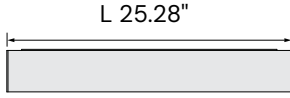

3 Feet

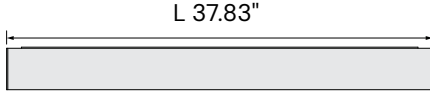

4 Feet

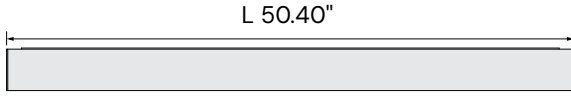

8 Feet

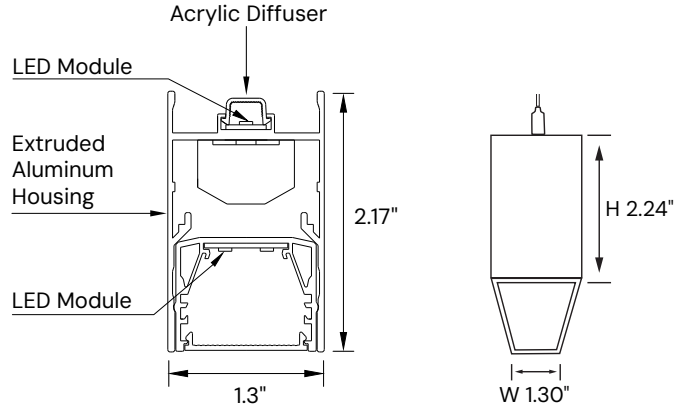
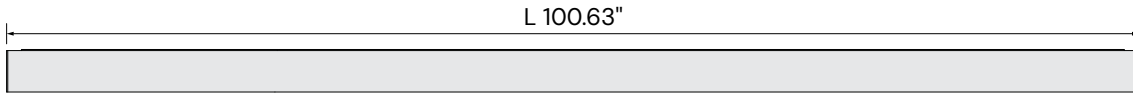

WATTAGE & LUMENS

Lens	Length	Wattage Selectable	25% Up / 75% Down		100% Down	
			Efficacy	Lumen Output	Efficacy	Lumen Output
Flat	2'	20/15/10W	850lm/ft	900-1700lm	800lm/ft	800-1600lm
	3'	30/23/15W		1300-2600lm		1200-2400lm
	4'	40/30/20W		1700-3400lm		1600-3200lm
	8'	80/60/40W		3400-6800lm		3200-6400lm
Louver	2'	20/15/10W	750lm/ft	750-1500lm	700lm/ft	700-1400lm
	3'	30/23/15W		1200-2300lm		1100-2100lm
	4'	40/30/20W		1500-3000lm		1400-2800lm
	8'	80/60/40W		3000-6000lm		2800-5600lm
Glow	2'	20/15/10W	1000lm/ft	1000-2000lm	950lm/ft	950-1900lm
	3'	30/23/15W		1500-3000lm		1500-2900lm
	4'	40/30/20W		2000-4000lm		1900-3800lm
	8'	80/60/40W		4000-8000lm		3800-7600lm

SHAPE DESIGNS

Pendant

Flat Lens

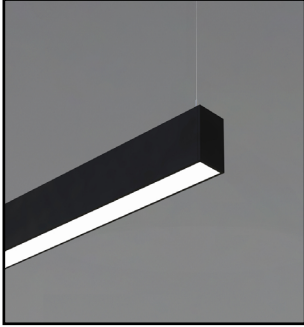

Louver Lens



Glow Lens

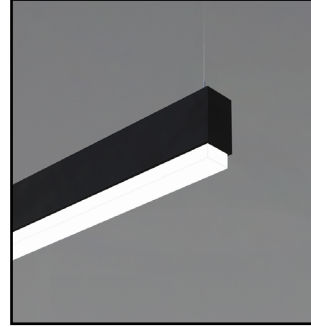

Surface

Flat Lens



Louver Lens



Glow Lens



Wall

Flat Lens



Louver Lens



Glow Lens



MOUNTING LOCATION



JOINER OPTIONS

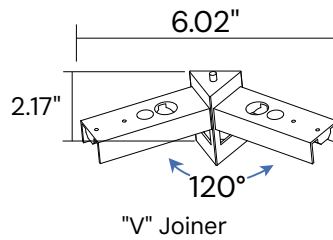
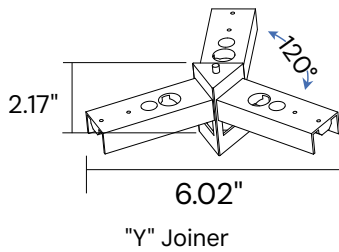
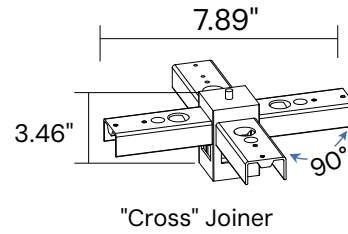
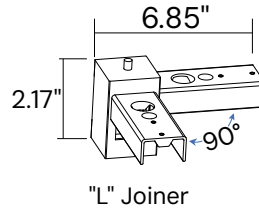
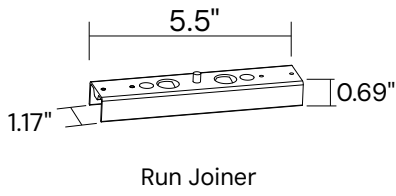

LIGHT DISTRIBUTION

2 different options via DIP switch for Pendant & Wall mount

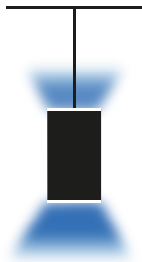

25% Up, 75% Down

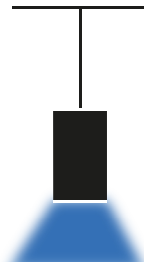

100% Down

AVAILABLE MOUNTINGS

Accessories for Surface & Wall (Included)

Mounting Kits



AVAILABLE MOUNTINGS

Pendant Canopy Style

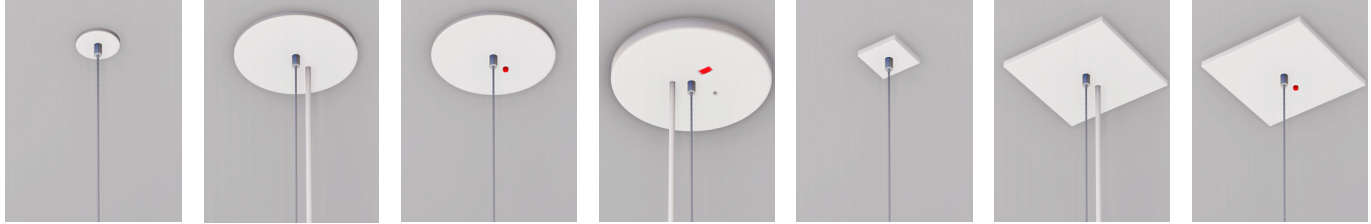

1.6" Round
(Non-Power Feed)

4.5" Round
(Power Feed)

4.5" Round with
Emergency Driver
(Non-Power Feed)

5.8" Round with
Occupancy
Sensor
(Power Feed)

1.6" Square
(Non-Power Feed)

4.5" Square
(Power Feed)

4.5" Square with
Emergency Driver
(Non-Power Feed)

Hard Drywall Ceiling

Mount to J-box

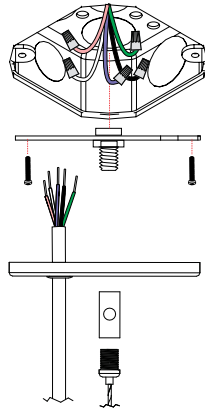

Grid Ceiling

Compatible with 9/16" and 15/16" T-bar and Screw Slot

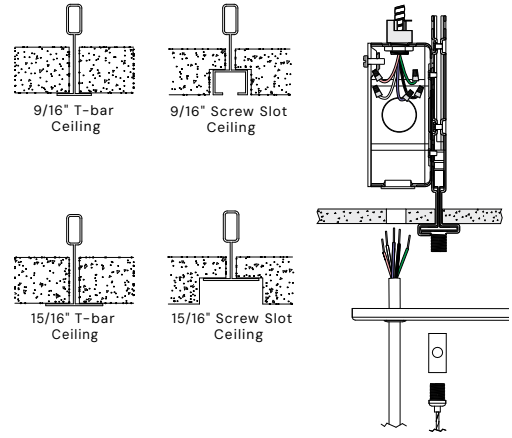

Pendant Accessories for Hard Drywall and Grid Ceiling (Included)

Hard Drywall Ceiling Canopy Kits



Grid Ceiling Canopy Kits



Junction Box



Aircraft Cable Kits



Power Cord Kits



T-grid Clips



CONTINUOUS RUN CHART (120V)

Run Length (ft)	Run Configuration	Run Joiner	Power Cable	Aircraft Cable	Canopy
2	2'	-	1	2	2
4	4'	-	1	2	2
6	4'+2'	1	1	3	3
8	8'	-	1	2	2
10	8'+2'	1	1	3	3
12	8'+4'	1	1	3	3
14	8'+4'+2'	2	1	4	4
16	8'+8'	1	1	3	3
18	8'+8'+2'	2	1	4	4
20	8'+8'+4'	2	1	4	4
22	8'+8'+4'+2'	3	1	5	5
24	8'+8'+8'	2	1	4	4
26	8'+8'+8'+2'	3	1	5	5
28	8'+8'+8'+4'	3	1	5	5
30	8'+8'+8'+4'+2'	4	1	6	6
32	8'+8'+8'+8'	3	1	5	5
34	8'+8'+8'+8'+2'	4	1	6	6
36	8'+8'+8'+8'+4'	4	1	6	6
38	8'+8'+8'+8'+4'+2'	5	1	7	7
40	8'+8'+8'+8'+8'	4	1	6	6

Note: 4.5" canopy is designed for power cable

Individual

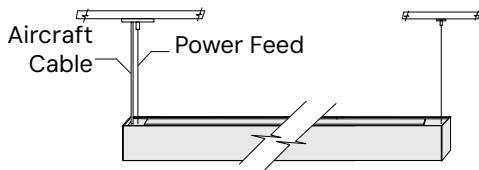

Continuous Run

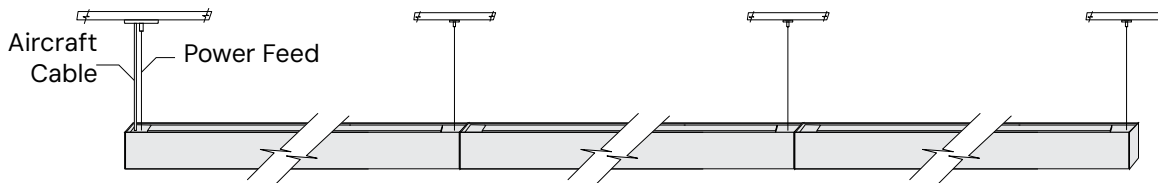

120VAC: Connections up to 40ft.
277VAC: Connections up to 100ft.

EXTERNAL EMERGENCY BATTERY WITH TEST SWITCH

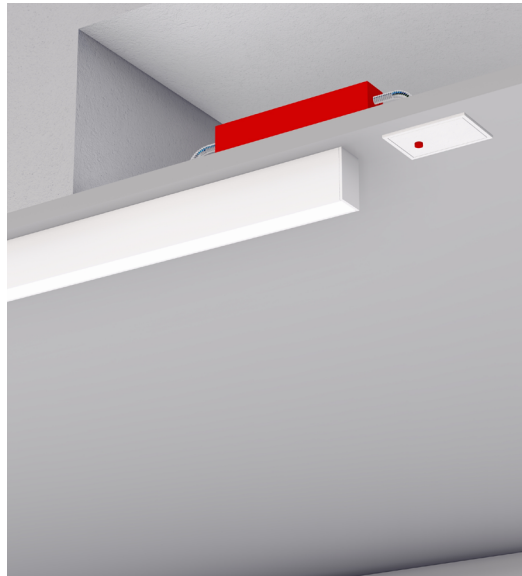

All mounting options come with UL and CEC Listed LED emergency drivers. In the event of an AC power failure, the system automatically switches to emergency mode, providing at least 90 minutes of illumination. Once power is restored, it seamlessly returns to charging mode, ensuring compliance with critical life-safety lighting requirements.



Choose between 8W or 25W emergency back-up battery to ensure essential lighting during power outages.

These options also simplify wiring, helping to reduce labor costs.

Code-Required Testing Switch

First Self-Test:

The system will conduct a functional test 3 seconds after installation to verify wiring and battery output. If there is a failure or error, the indicator LED will turn off or flicker.

Second Self-Test:

A second test will occur 120 minutes later to recheck the system. If the test fails, it will automatically repeat up to 4 times, every 120 minutes.

Monthly Self-Test:

The system will perform an automatic test every 30 days, lasting 3 seconds, to check wiring and battery output. In the event of a failure or error, the indicator LED will turn off or flicker.

OCCUPANCY SENSOR



This internal microwave bi-level sensor system control is based on motion and/or daylight contribution with a harvest feature, detecting a 360° range for some areas that require a light change notice before switching off.

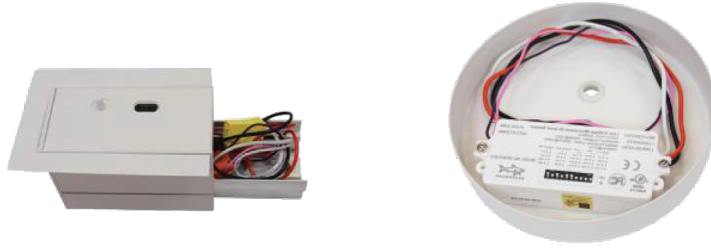

Specification

Power Supply	120/277 VAC 50/60Hz
Maximum load @ -40°F ~ +158°F (-40°C ~ +70°C)	Resistive/ Tungsten 600W @ 120V Electronic Ballast (LED) 800VA @ 120V, 1200VA @ 277V
HF System	5.8GHz CW
Dim Control Output	0-10V, Max 0.25mA sinking current
Detection Radius/Angle	Max 26ft. (8m)/360
Mounting Height	Max 12ft
Humidity	Max 95% RH
Temperature	-40°F ~ +158°F (-40°C ~ +70°C)

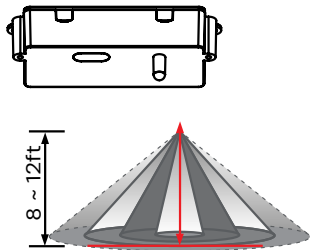

Height of installation 8~12ft

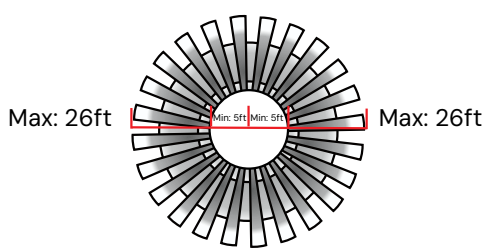

(Height of installation 8ft)
Detection Range

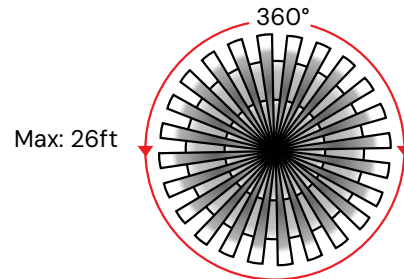

Detection Angle

PHOTOMETRY

Pendant and Wall

4' / Flat/ Up 25%, Down 75%/ 4000K

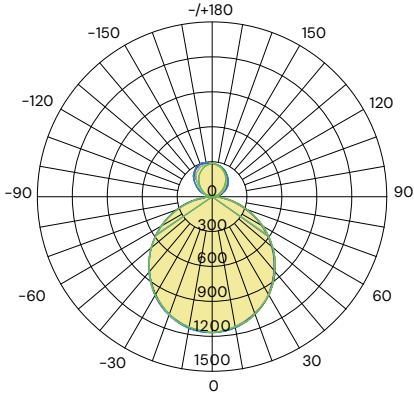

AVERAGE BEAM ANGLE (50%): 110.6°

Lumens: 3988.37 lm
Watts: 40 W
LPW: 95.24 Lm/W
CCT: 4000K

UNIT:cd
 — C0/180, 110.5°
 — C30/210, 110°
 — C60/240, 110.7°
 — C90/270, 111.1°

Zonal Flux Diagram

T	C0	C45	C90	C135	C180
5	1161	1153	1152	1155	1164
10	1143	1132	1135	1136	1149
15	1113	1105	1118	1111	1122
20	1074	1075	1072	1082	1085
25	1025	1022	1025	1031	1038
30	967.0	962.6	979.2	973	982.2
35	901.2	901.1	909.2	913.3	918.5
40	828.7	835.1	839.2	832.5	847.7
45	750.3	752.6	769.3	667.9	770.7
50	666.2	669.8	682.1	530.6	687.8
55	577.9	587.1	594.9	428.2	600.2
60	485.9	490.2	507.8	343	508.6
65	390.8	395.5	411.5	265.1	414.4
70	295.6	302	315.1	196.2	319.2
75	203.8	209.1	218.8	135.3	216.6
80	116.8	123.2	146.5	79.88	73.23
85	41.84	62.64	74.14	40.19	23.29
90	2.992	3.212	1.821	1.957	1.958
95	4.106	18.65	10.98	14.65	1.139
100	18.52	34.76	20.13	28.05	10.79
105	40.60	62.17	29.29	55.27	44.13
110	73.56	89.6	48.53	83.83	83.85
115	121.2	110.1	67.77	110.3	124.3
120	144.1	127.3	87	137.9	146.4
125	165.4	145.1	110.7	167.9	172.6
130	181.9	161.8	134.3	191.6	201.7
135	197.1	179	158	216.4	229.4
140	211.4	197.4	180.1	240	251.8
145	225.1	213.2	202.3	255.6	268.4
150	238.9	228.6	224.4	269.9	286.9
155	252.7	244.2	239.9	283.5	292.6
160	264.3	257.7	255.4	292.9	301.3
165	272.5	265	270.9	293.2	302.1
170	278.2	272.6	277	292.1	295.6
175	283.7	280.6	283.1	289.8	284.5
180	289.2	289.2	289.2	289.2	286.8
DEG	LUMINOUS INTENSITY:cd				

Zonal Lumens

T	φ total
0-5	27.74
5-10	109.7
10-15	243
15-20	423.2
20-25	643.4
25-30	896.1
30-35	1173
35-40	1463
40-45	1755
45-50	2038
50-55	2302
55-60	2540
60-65	2746
65-70	2914
70-75	3040
75-80	3125
80-85	3173
85-90	3189
90-95	3193
95-100	3203
100-105	3222
105-110	3253
110-115	3296
115-120	3348
120-125	3408
125-130	3474
130-135	3545
135-140	3619
140-145	3692
145-150	3762
150-155	3826
155-160	3881
160-165	3962
165-170	3959
170-175	3979
175-180	3986
	UNIT: lm

Luminance cd/(m2)

G(DEG)	C0/180	C90/270
85	11429	20254
80	16017	20082
75	18749	20126
70	20578	21937
65	22015	23181
60	23138	24181
55	23988	24697
50	24678	25266
45	25264	25902

PHOTOMETRY

4' / Flat / Down 100% / 4000K

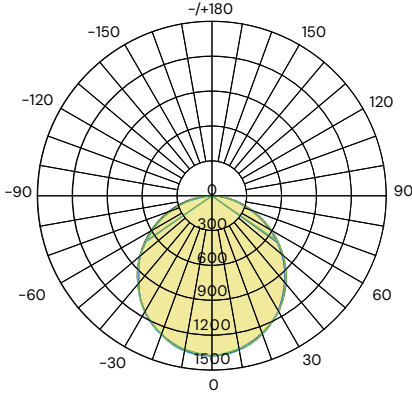

AVERAGE BEAM ANGLE (50%): 110.4°

Lumens: 3771.05 lm
Watts: 40 W
LPW: 89.39 Lm/W
CCT: 4000K

UNIT:cd
— C0/180, 109.7°
— C30/210, 110°
— C60/240, 110.7°
— C90/270, 111.1°

Zonal Flux Diagram

T	C0	C45	C90	C135	C180
5	1369	1359	1357	1361	1373
10	1347	1334	1337	1336	1354
15	1313	1303	1316	1299	1323
20	1266	1267	1262	1247	1272
25	1208	1205	1208	1186	1219
30	1140	1135	1154	1122	1153
35	1062	1062	1071	1050	1072
40	976.4	983.8	988.8	957.6	974.4
45	883.7	886.6	906.5	783.1	888.6
50	784.8	789.2	803.8	626.2	801.2
55	680.4	691.8	701.2	502.2	690.3
60	571.8	577.8	598.6	404.1	585.1
65	460.1	466.6	485.1	314.0	479.4
70	348.3	356.3	371.6	233.5	367.7
75	239.5	247.0	258.1	160.0	249.3
80	136.7	145.7	172.8	93.10	83.41
85	48.16	74.26	87.56	46.56	25.93
90	2.283	4.164	2.321	1.715	1.697
95	5.970	4.673	2.367	2.337	0.3687
100	5.849	5.182	2.414	2.964	0.5275
105	6.116	5.362	2.460	3.700	0.6953
110	6.410	5.514	2.778	4.412	0.9148
115	6.513	5.754	3.095	4.988	1.181
120	6.695	6.041	3.413	5.559	1.409
125	6.718	6.259	3.696	6.234	1.652
130	6.531	6.176	3.978	6.039	1.886
135	6.339	6.021	4.261	5.881	2.124
140	6.017	5.736	4.464	5.996	2.348
145	5.489	5.455	4.667	6.071	0.553
150	4.784	5.106	4.869	5.956	2.759
155	4.103	4.691	4.900	5.660	2.922
160	3.706	4.330	4.931	5.248	3.076
165	3.646	4.055	4.961	4.881	3.212
170	3.768	4.052	4.738	4.666	3.347
175	3.927	4.171	4.514	4.455	3.389
180	4.290	4.290	4.290	4.290	3.431
DEG	LUMINOUS INTENSITY:cd				

Zonal Lumens

T	Φ total
0-5	32.69
5-10	129.3
10-15	286.3
15-20	498.3
20-25	757.0
25-30	1054
30-35	1379
35-40	1719
40-45	2062
45-50	2396
50-55	2707
55-60	2987
60-65	3229
65-70	3427
70-75	3576
75-80	3676
80-85	3732
85-90	3751
90-95	3752
95-100	3753
100-105	3754
105-110	3756
110-115	3757
115-120	3759
120-125	3761
125-130	3762
130-135	3764
135-140	3765
140-145	3767
145-150	3768
150-155	3769
155-160	3770
160-165	3770
165-170	3771
170-175	3771
175-180	3771
	UNIT: lm

Luminance cd/(m2)

G(DEG)	C0/180	C90/270
85	13157	23921
80	18739	23694
75	22034	23739
70	24246	25866
65	25919	27328
60	27229	28503
55	28242	29107
50	29070	29775
45	29757	30523

COMPATIBLE DIMMERS

	ALCON LIGHTING	LUTRON	LEVITON®
0-10 V	2100 2101 2102	Diva DDTV	IP-710-DL

Alcon Lighting 12100-12 Architectural LED Linear Direct/Indirect Light Fixture

COLOR TEMPERATURE GUIDE

2700K	3000K	3500K	4000K	5000K
WARM WHITE	SOFT WHITE GLOW	NEUTRAL GLOW	COOL WHITE GLOW	DAYLIGHT GLOW
friendly personal intimate	soft warm pleasing	sociable inviting non-threatening	neat clean efficient	bright cool alert
HOMES LIBRARIES RESTAURANTS	HOMES HOTEL ROOMS LOBBIES RETAIL STORES	EXECUTIVE OFFICES RECEPTION AREAS SUPERMARKETS	OFFICES CLASSROOMS MASS MERCHANTISERS SHOWROOMS	GRAPHICS INDUSTRY HOSPITALS GALLERIES BEAUTY SALONS
X	✓	✓	✓	X