

FIXTURE SPECIFICATIONS

INTENDED USE

Aluminum, architectural-grade linear LED downlighting is the most versatile of its class. Available for pendant, wall, ceiling surface, recessed, drywall, trimless, t-bar and wood cladding applications. This two-inch product is field color temperature selectable providing clean, high-CRI LED light for architectural residential, hospitality and commercial use. Voltage, length and lumen outputs vary. Compatible with wood ceilings. Dimming and emergency backup battery features available.

PRODUCT FAMILY

- 12100-23-P** Pendant Mount
- 12100-23-W** Wall Mount
- 12100-23-S** Surface Mount
- 12100-23-R** Recessed Mount

FEATURES

- Construction:** Aluminum housing
- Color Temperature:** 3000K/3500K/4000K Color temperature selectable switch/field adjustable
- Indirect Mounting:** For most effective indirect lighting result, mount at no less than 18" from the ceiling
- Voltage:** 120V-347V
- Dimming:** 0-10V 5-wire dimming from 10-100%
- CRI:** 80+
- Beam Spread:** 120°
- Life:** +60,000 reported L70 hours @ 55°C
- Power Factor:** >0.90
- Operating Temperature:** -22°F to 122°F
- Warranty:** 5 years carefree for parts & components (labor not included)
- Listings:** cETLus, IC Rated, DLC listed (2', 4' & 8'), Suitable for wet Location

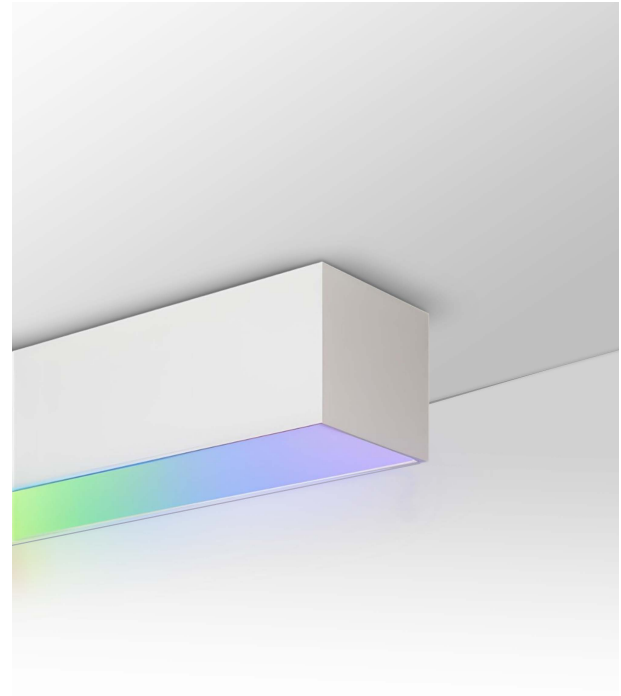

Alcon 12100-23 Color Selectable Linear LED Recessed/Wall/Ceiling/ Surface /Pendant

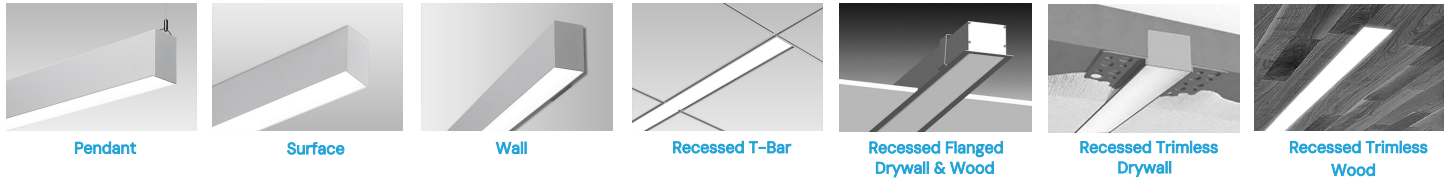

ORDERING INFORMATION Example: (12100-23-P-OP-2-D20-8-WH)

Model	Mounting	Lens Type	Length	Downlight	Uplight	CRI	Flange Finish ²	Options
12100-23	P¹ Pendant	OP Opal Polycarbonate			(Blank) Not Required	8	WH ^{Standard}	EM7 Emergency Back-Up Battery (700 lm)
	W Wall	LVR Louver	2 2 ft	D20 20 Watts	I10 10 Watts	80+ 9 90+	White BK Black	EM14 Emergency Back-Up Battery (1400 lm)
	S Surface		4 4 ft	D35 35 Watts	I15 15 Watts		SL ³ Silver	EM20 Emergency Back-Up Battery (2000 lm)
	RT Recessed T-Bar		6 6 ft	D50 50 Watts	I30 30 Watts			
	RF Recessed Flanged		8 8 ft	D70 70 Watts	I30 30 Watts			
	RTLD Recessed Trimless Drywall							
	RTLW Recessed Trimless Wood							

¹ 6' Adjustable Aircraft Cable included

² Not available for Recessed T-Bar, Recessed Trimless Drywall or Recessed Trimless wood options

³ Available in 4' and 8' only

Color Temp & Lumen Chart

Length	Downlight Wattage	Down & Up Light Wattage	Color Temperature & Lumen
2 Foot	20W Direct	20W Direct & 10W Indirect	4000K - 4434 Lum
			3500K - 3705 Lum
			3000K - 3510 Lum
4 Foot	35W Direct	35W Direct & 15W Indirect	4000K - 6500 Lum
			3500K - 6175 Lum
			3000K - 5850 Lum
6 Foot	50W Direct	50W Direct & 30W Indirect	4000K - 10400 Lum
			3500K - 9880 Lum
			3000K - 9360 Lum
8 Foot	70W Direct	70W Direct & 30W Indirect	4000K - 13000 Lum
			3500K - 12350 Lum
			3000K - 11700 Lum

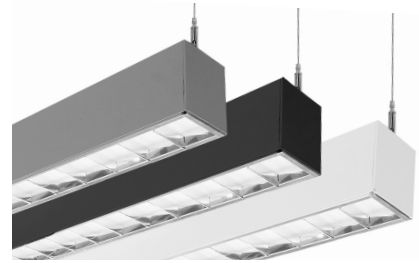

LV | Louver Lens

Mounting Details

1" Grid Mounting Options

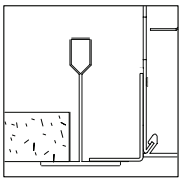

Surface

Flange Detail

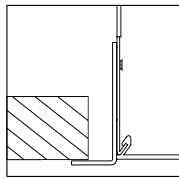

Recessed T-Bar

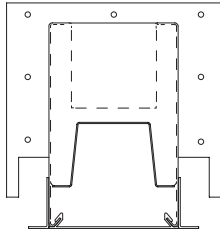

Wall

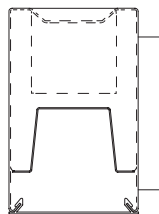

Spackle Flange Trimless

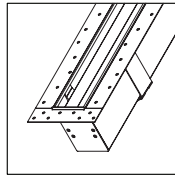

Cable Pendant

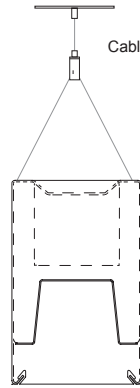

Ceiling to Wall

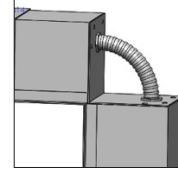

Stem Pendant

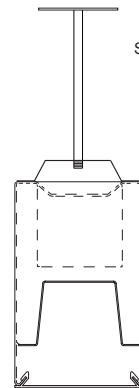

3.1" (80mm)

2.8" (70mm)

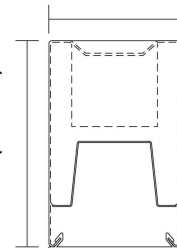

Recessed Wood Installation

- Make recessed preparations by installing a horizontal plank of wood on top of the wood ceiling at recessed height of 3-3/8".
- Screw and anchor kit provided with each fixture can be used to fasten the top of the fixture to the wood plank through the holes on top of the fixture.
- You can also install vertical wood boards on top of the ceiling at the edge of the opening and open the fixture and put screws through the sides of the fixture housing to fasten it to the wood boards.

Pendant Installation

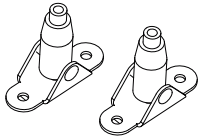

Steel wire rope pedestal 2pcs

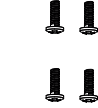

PM4*8 Screw 4pcs



Plastic Anchor 2pcs



PA4*30 Screw 2pcs

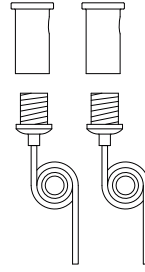

Steel wire rope 2pcs

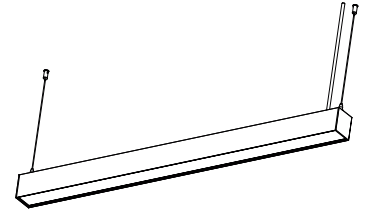

Plastic anchor 2pcs

No.	Size	A(in)	B(in)
1	2FT	22.205	/
2	4FT	45.827	/
3	6FT	69.449	/
4	8FT	46.535	46.535

1. Drill a hole of 3/16" in diameter at the location required for installation. Then install the plastic anchor to the hole with hammer.

4. Press down the inner hole of the steel wire rope pedestal, let the steel wire rope go through the hole.

2. Insert PA4*30 screws into the screw holder and then drill into the plastic anchor.

- Screw Holder
- PA4*30 Screw
- Steel wire rope holder
- Steel wire rope

5. Connect L, N, GND, DIM+ and DIM- of AC input wire to L, N, GND, DIM+ and DIM- respectively of AC terminal.

- DIM+(purple)
- DIM-(gray)
- GND(yellow and green)
- N(white)
- L(black)
- In put AC120~347V

OFF

3. Lock the steel wire rope pedestal to the ends plates with PM4*8 screws.

6. Press the to pend of the steel wire rope pedestal to adjust the steel wire rope, and then finish the installation.

ON

Linear

Pendant Canopy Installation

NO.	Size	A(in)	B(in)	C(in)	D(in)	E(in)
1	2ft	3.346	18.858	3.346	/	/
2	4ft	3.346	42.480	3.346	/	/
3	6ft	3.346	66.102	3.346	/	/
4	8ft	3.346	43.189	3.346	43.189	3.346

1. Drill a hole of 3/16" in diameter as shown in the figure at the location required for installation. Then hammer the plastic anchor into the hole.

2. Insert PA4*35 screws into the M type mounting bracket and then drill into the plastic anchor.

3. Lock the steel wire rope pedestal to the ends plates with PM4*8 Screws.

4. Press down the inner hole of the steel wire rope pedestal, let the steel wire rope go through the hole.

5. Insert the steel wire rope holder into the middle hole of the canopy and tighten the steel wire rope holder with hex nut; Clip the cable protective cover into the AC line hole of the canopy.

6. Insert the stainless steel wire into the inner hole of the steel wire rope holder

7. Insert the AC input cable through the cable protective cover and connect it with the AC line by the corresponding connection wire with L, N, GND.

8. Adjust the length of the AC input cable, align the side hole of the canopy and the M mounting bracket as shown in the figure, then tighten the screw.

9. The installation is completed.

Surface Mount Installation

Installation Kits

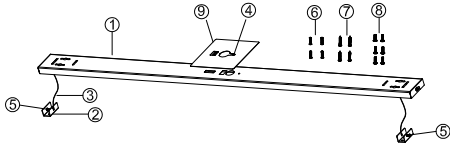

1	Surface Mount Bracket	1199*69*20mm
2	Surface Mount Bracket 2	43*22.5*18mm
3	Safety cable	L=150mm
4	Round head pull nail	4*5mm
5	Countersunk head screw	PM4*10
6	Cross head tapping screw	PA4*35M
7	Plastic Anchor	4*28mm
8	Round head machine screws	PM4*8mm
9	Decorative plate	140*140mm T=0.6mm

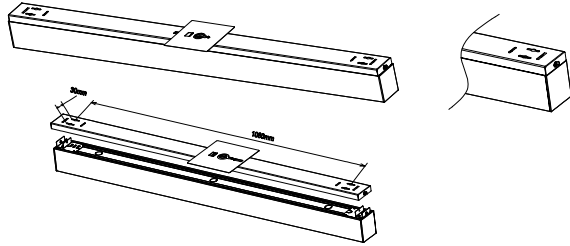

1. Drill Hole on the ceiling based on the Length of the fixture, fix the plastic anchor in the hole .

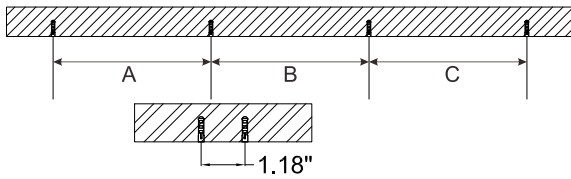

No.	Size	A(in)	B(in)	C(in)
1	2FT	18.898	/	/
2	4FT	42.520	/	/
3	6FT	25.984	14.173	25.984
4	8FT	37.795	14.173	37.795

2. Fix the surface mount bracket on the ceiling with PA4*30 screw.

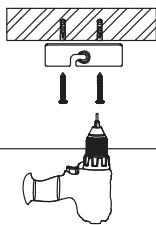

3. Hook the safety cable of the fixture on the slot of the surface mount bracket.

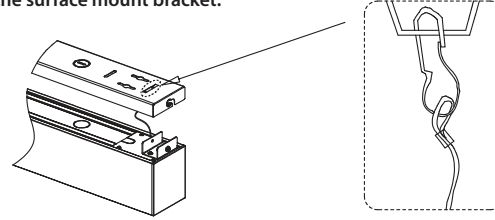

4. Wiring the fixture with the supply power, clear up the wires and safety cables, clip the fixture into the slot of the surface mount plate on two sides.

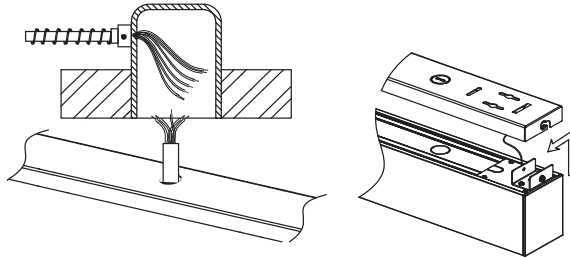

5. Fix screws on two side of the fixture.

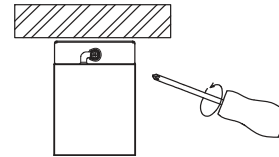

6. Turn on the light.

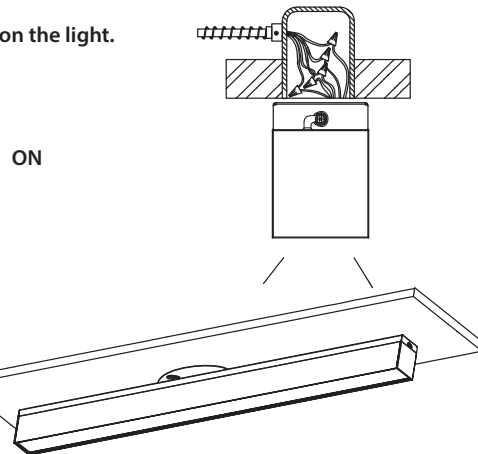

Wall Mount Installation

Installation Kits

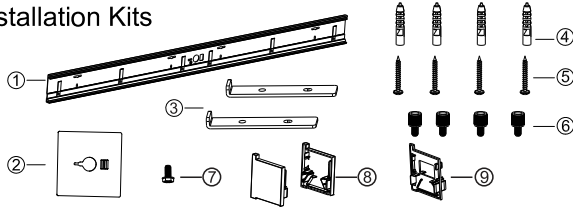

1	C Wall-mount Bracket	1PC
2	Square Decorative	1PC
3	L support	2PCS
4	Plastic Anchor	4PCS
5	Cross head tapping	4PCS
6	Hand screw	4PCS
7	Screw	1PC
8	End cap	2PCS
9	Linkable braket	1PC

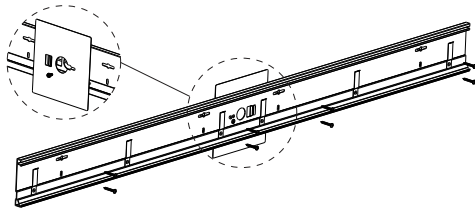

1. Drill Hole on the wall based on the Length of the Fixture, Fix the plastic anchor in the hole and fix the Wall Mount Bracket on the Wall.

2. Push the L support bracket into the wall mount bracket as followed.

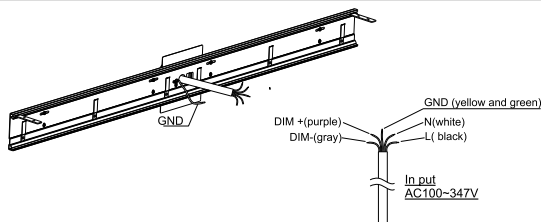
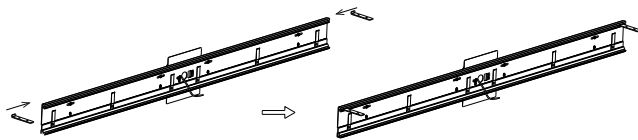

3. Connect L, N, GND, DIM+ and DIM- of AC input wire to L, N, GND, DIM+ and DIM- respectively of AC wire.

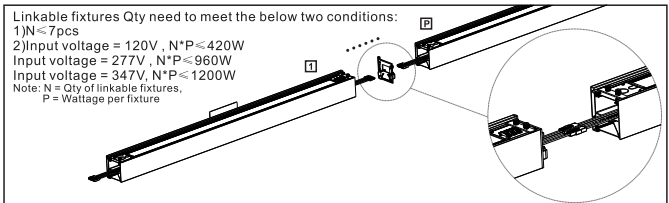
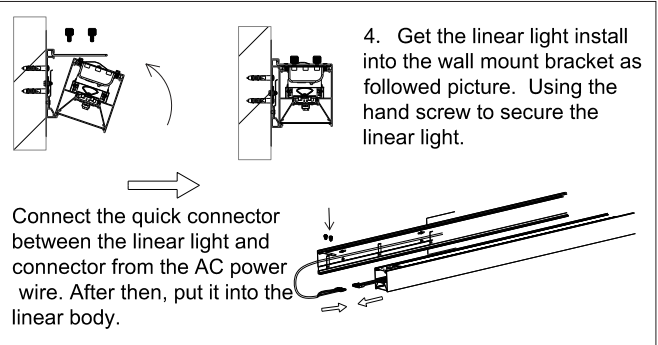

5. Linkable braket insert into one fixture , connect the male and female connector, the other part of linkable braket insert into the other fixture. Then the fixture fixed on the wall mounted kit .

6. Install the end caps, the connector wire must get through the correct place on the end caps as followed picture.

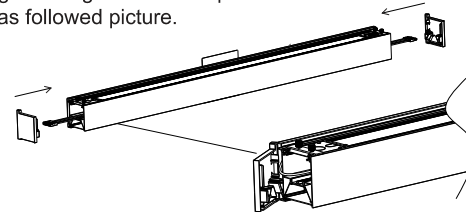

7. Turn on the light.



T-Bar Recessed Installation

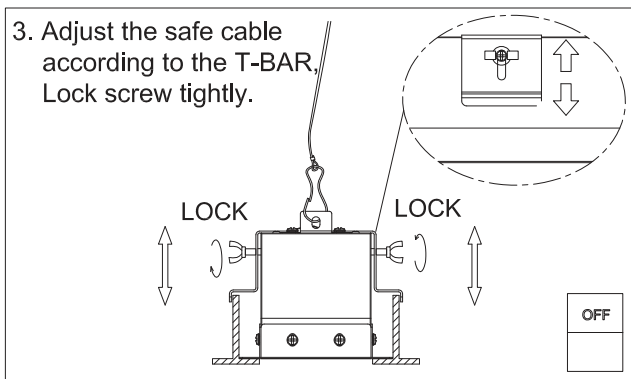
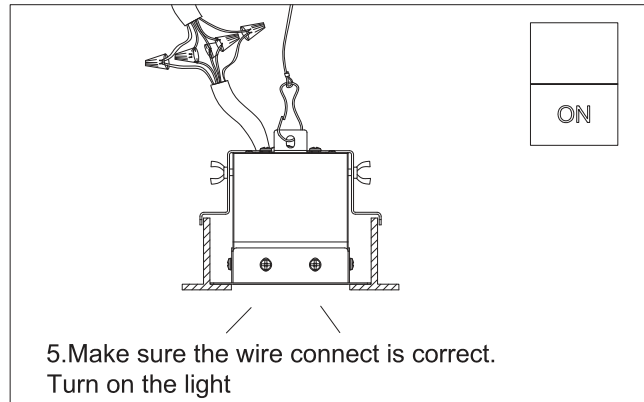
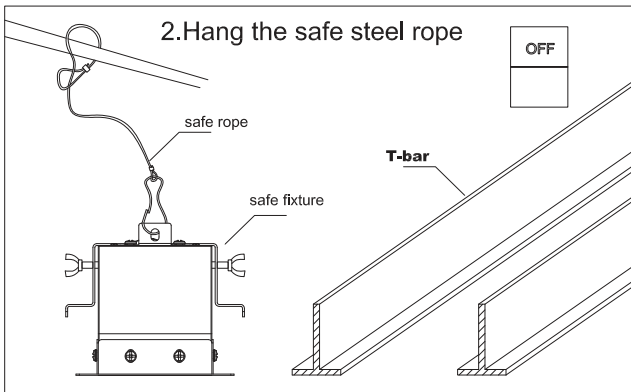
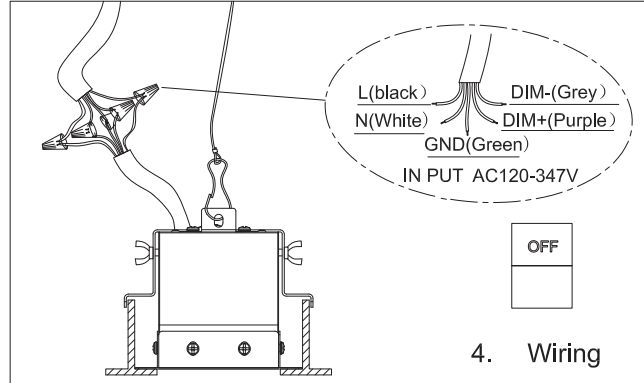
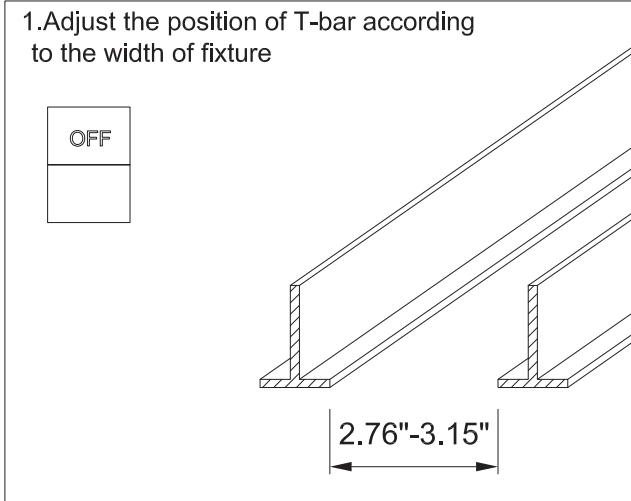

Dry Ceiling Recessed Installation

1. Open the hole according to the size of the light, and pull out the AC wire.

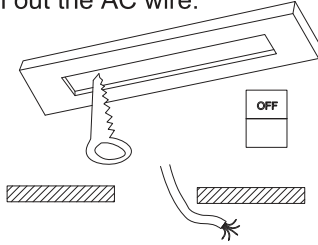

5. After finish wire, put the whole light into the hole.

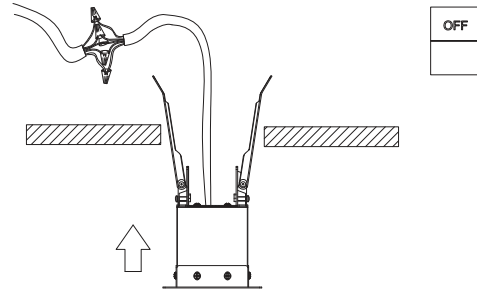

2. Pull up the spring clamp and fix with rope (Adjust the size according to hole size)

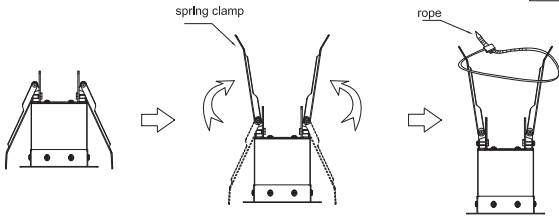

6. Done, turn on the light.

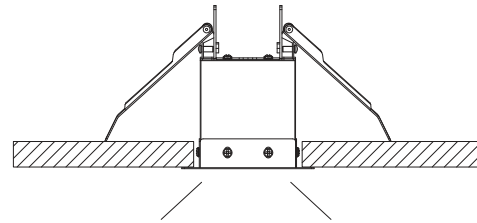

3. Remove the rope

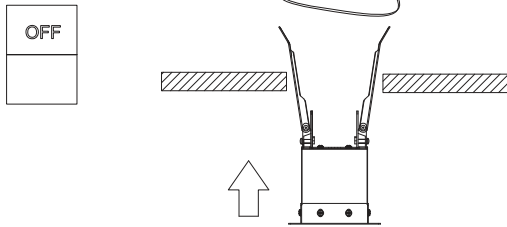

4. See the blew drawing, wire with connector.

