

FIXTUR. SPECIFICATIONS

INTENDED USE

Available for use in wet locations, our 12100-41 features multiple options for lumen output, driver type and is able to be ordered with custom finish. Available in Pendant, surface and wall mount, our 4 inch wide, wet location linear is suitable for commercial and residential applications. Pendant variant is capable of 360 degree rotation.

PRODUCT FAMILY

12100-41-P Pendant Mount
 12100-41-W Wall Mount
 12100-41-S Surface Mount

AVAILABLE LENGTHS

2FT, 3FT, 4FT, 6FT & 8FT
Continuous Run | Consult Factory
Custom Length | Consult Factory

FEATURES

Construction: Die-formed and welded 22-gauge cold rolled steel, painted finish with premium paint

Continuous Run: Full ability to tandem mount for continuous run application

Indirect Mounting: For most effective indirect lighting result, mount at no less than 18" from the ceiling

Custom Design: Offered with pre-fabricated and fully illuminated corners

Lens: Glare-free frosted acrylic flat snap-in lens for even distribution

Voltage: 50/60 Hz Constant current 0-10V @ 120-277V, TRIAC & ELV @ 120V

Dimming: 0-10V, TRIAC (Forward-phase), ELV (Reverse-phase)

Life: +60,000 Reported L70 Hours @ 55°C

Operating Temperature: 4°F (-20°C) ~ 122°F (50°C).

Warranty: 5 years (Dynamic Colors) carefree for parts & components.

(Labor not included)

Listings: cULus Listed, UL listed for wet location

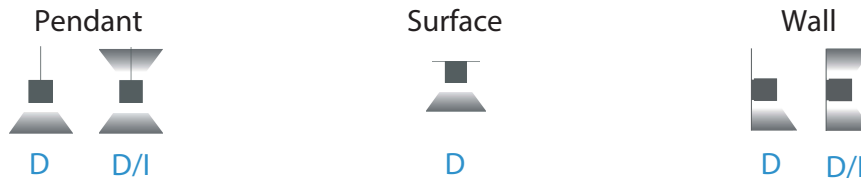
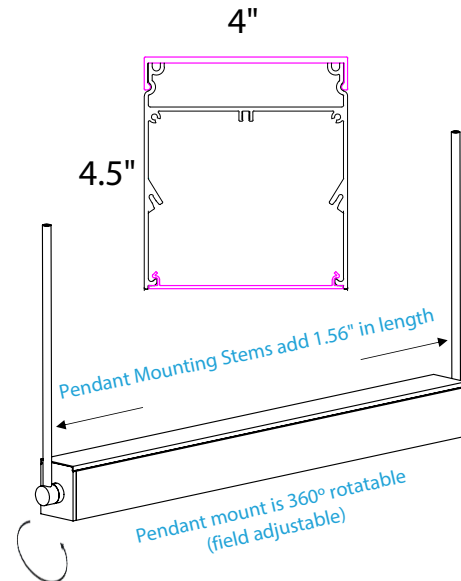

Alcon Lighting 12100-41 Architectural LED Linear Wet Location Direct/Indirect Light



ORDERING INFORMATION Example: (12100-41-P-D-D4-S-4-27K-010-WH-WH-8-FL)

MODEL	12100-41 4" x 4" Wet Location Linear		
MOUNTING	P Pendant (360° field adjustable rotation) W Wall S Surface		
OPTICS	D Direct DI Direct / Indirect		
LED DOWNLIGHT¹⁹ <i>Wattage & Lumens per foot</i>	DYNAMIC WHITE D4 4.5 Watts 665 lms D6 6.75 Watts 825 lms D9 9 Watts 1140 lms D12 12 Watts 1371 lms D13 13.5 Watts 1614 lms Dx Specify Lumens ¹⁷ (Min 113 lms - Max 2000 lms)	TUNABLE WHITE TW-4 4.5 Watts 734 lms ¹⁴ TW-6 6.75 Watts 924 lms ¹⁴ TW-9 9 Watts 991 lms ¹⁴ TW-12 12 Watts 1384 lms ¹⁴ TW-13 13.5 Watts 1467 lms ¹⁴ TW-DLO 4.4 Watts 494 lms ¹⁵ TW-DHO 8.8 Watts 988 lms ¹⁵	RGBW¹³ RGBW-D10 10 Watts 425 lms
LED UPLIGHT^{1,2,19} <i>Wattage & Lumens per foot</i>	DYNAMIC WHITE Blank Not Required I4 4.5 Watts 683 lms I6 6.75 Watts 976 lms ³	TUNABLE WHITE Blank Not Required TW-4 4.5 Watts 734 lms ¹⁴ TW-6 6.75 Watts 924 lms ¹⁴ TW-ILO 4.4 Watts 494 lms ¹⁵ TW-IHO 8.8 Watts 988 lms ¹⁵	RGBW¹³ Blank Not Required RGBW-I10 10 Watts 425 lms
SHAPE	Sx Single Run x = 2', 3', 4', 6' or 8' CRx Continuous Run x = Length (Specify in Feet)		
COLOR TEMPERATURE	DYNAMIC WHITE 27K 2700K Warm White ¹⁸ 30K 3000K Soft White 35K 3500K Neutral White 40K 4000K Cool White 50K 5000K Daylight	TUNABLE WHITE TW2750 2700-5000K (Wired) ⁷ TW2065 2000-6500K (Wired) ⁷ TW2762 2700-6200K (Wireless) ^{4,8}	RGBW¹³ RGBW30 RGB + W (3000K) RGBW42 RGB + W (4200K)
DRIVER	DYNAMIC WHITE O10 0-10V 1% ^{Standard} TRI Triac (120V) ELV Electronic Low Voltage ES566 eldoLED 0-10V SOLOdrive BLS Bi-Level Step 40/100% BLSAB Bi-Level Step AB /100% TLS Tri-Level Step 30/70/100% TLSAB Tri-Level Step AB /30/100%	TUNABLE WHITE 050 Tunable White 0-10V	RGBW¹³ 24V RGBW & Wireless Tunable White ⁸
FINISH	WH White (Matte) ^{Standard} SL Silver (Matte)	BK Black (Matte) RAL# Specify RAL # (Pg. 3)	
PENDANT MOUNTING	Blank Not Required	ST2 2' Stem ¹² ST4 4' Stem ¹² STx Specify x' in Feet (Max 8') ¹²	
PENDANT CEILING TYPE	Blank Not Required	T T-Bar Ceiling	H Hard Ceiling SH Hard Ceiling Sloped
STEM / CANOPY FINISH	Blank Not Required		
	WH/WH White Stem / White Canopy	BK/BK Black Stem / Black Canopy	RAL#/RAL# Black Stem / Specify RAL # (Page 3)
CRI	8 80+ CRI	9 90+ CRI ⁹	
CONTROLS	DYNAMIC WHITE Blank Not Required	TUNABLE WHITE⁴ TW-WWR-BK Wireless Black Wall Remote TW-WWR-WH Wireless White Wall Remote TW-DWR-BK Wireless Black Desktop Remote	RGBW¹³ RGBW-APP iOS/Android Bluetooth App RGBW-SZ Wireless RF Remote Control Single Zone RGBW-MZ Wireless RF Remote Control Multi Zone
WARRANTY	Blank 5 Year Warranty ^{Standard}	W7 7 Year Warranty	W10 10 Year Warranty
OPTIONS	EM8 8W Emergency Battery EM15 15W Emergency Battery EM20 20W Emergency Battery	ELCU-200 Fail-to-on Emergency UL924 GTD Bodine Generator Transfer Device COC Chicago Code Compliance Separated EM Feed	

Alcon Lighting 12100-41 Architectural LED Linear Wet Location Direct/Indirect Light

1 Only available for Pendant and Wall Mounts with General Downlight Optics
 2 RGBW downlight can be paired with a static color temperature uplight or RGBW uplight
 3 Only compatible with D6 & D12 Downlight Wattages
 4 Wireless control must be specified (page 5)
 5 Minimum Length of 2 Feet
 6 Draw your custom shape and send us your idea to rfq@alconlighting.com
 7 Must be Paired with 050 Driver
 8 Must specify for RGBW & Wireless Tunable White 24V Driver
 9 Not available for RGBW
 10 For RGBW, AB is only available though RGBW-MZ control or RGBW-APP

11 Control system must be specified for this feature
 12 Stem finish will be the same as fixture finish
 13 Bluetooth app control or wireless control must be specified for this feature (cannot be combined)
 14 Only for Wired Tunable White Control
 15 Only for Wireless Tunable White Control
 16 Not available for RT, RS, and RF mountings.
 17 Max lumen for 6' & 8' lengths is 1467 lms.
 18 Only available in 90CRI
 19 Maximum wattage is 75W per 4 feet







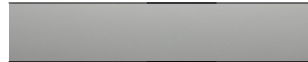

Available Finishes

Standard

	Matte White	RAL #9003
--	-------------	-----------

Set up fee and longer lead time will be applied on non-standard finishes.

Metropolitan

	Black	RAL #9011
	Silver	RAL #9022
	Asher Grey	RAL #7004
	Mason	RAL #7039
	Slate	RAL #7031
	Tech Grey	RAL #7016
	Chocolate Spice	RAL #8017
	Urban Native	RAL #8025
	Carmin	RAL #8028
	Reseda Green	RAL #6011

Vibrant

	Violet Dreams	RAL #4006
	Purple Red	RAL #3004
	Carmine Red	RAL #3002
	Rose	RAL #3017
	Pure Orange	RAL #2004
	Traffic Yellow	RAL #1023
	Daisy	RAL #1018
	Antique Spring	RAL #6019
	Island Skye	RAL #6027
	Sky Blue	RAL #5015

Mounting

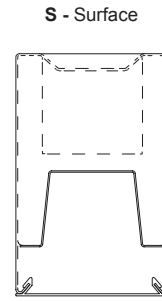
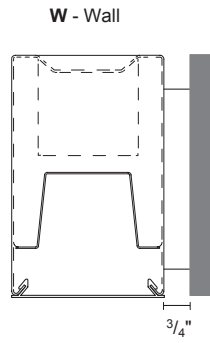
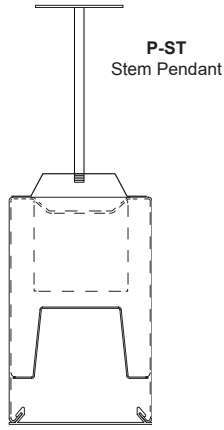

Photometrics (for Dynamic Color Temperatures)

Direct

12100-41-D4-S-4
Illuminance at a Distance

	Center Beam FC	Beam Width
1.7FT	551 FC	3.9 FT 3.1 FT
3.3FT	146 FC	7.6 FT 6.1 FT
5.0FT	63.7 FC	11.6 FT 9.2 FT
6.7FT	35.5 FC	15.5 FT 12.3 FT
8.3FT	23.1 FC	19.2 FT 15.2 FT
10.0FT	15.9 FC	23.2 FT 18.4 FT

■ Vert. Spread: 98.4°
■ Horiz. Spread: 85.1°

12100-41-D13-S-4
Illuminance at a Distance

	Center Beam FC	Beam Width
1.7FT	985 FC	3.9 FT 3.1 FT
3.3FT	261 FC	7.6 FT 6.1 FT
5.0FT	114 FC	11.6 FT 9.2 FT
6.7FT	63.4 FC	15.5 FT 12.3 FT
8.3FT	41.3 FC	19.2 FT 15.2 FT
10.0FT	28.5 FC	23.2 FT 18.4 FT

■ Vert. Spread: 98.4°
■ Horiz. Spread: 85.1°

12100-41-D4-S-8
Illuminance at a Distance

	Center Beam FC	Beam Width
1.7FT	1,102 FC	3.9 FT 3.1 FT
3.3FT	292 FC	7.6 FT 6.1 FT
5.0FT	127 FC	11.6 FT 9.2 FT
6.7FT	70.9 FC	15.5 FT 12.3 FT
8.3FT	46.2 FC	19.2 FT 15.2 FT
10.0FT	31.8 FC	23.2 FT 18.4 FT

■ Vert. Spread: 98.4°
■ Horiz. Spread: 85.1°

12100-41-D13-S-8
Illuminance at a Distance

	Center Beam FC	Beam Width
1.7FT	1,970 FC	3.9 FT 3.1 FT
3.3FT	523 FC	7.6 FT 6.1 FT
5.0FT	228 FC	11.6 FT 9.2 FT
6.7FT	127 FC	15.5 FT 12.3 FT
8.3FT	82.7 FC	19.2 FT 15.2 FT
10.0FT	56.9 FC	23.2 FT 18.4 FT

■ Vert. Spread: 98.4°
■ Horiz. Spread: 85.1°

Direct/Indirect

12100-41-D4-I4-S-4
Illuminance at a Distance

	Center Beam FC	Beam Width
1.7FT	467 FC	3.9 FT 3.3 FT
3.3FT	124 FC	7.6 FT 6.5 FT
5.0FT	54 FC	11.5 FT 9.8 FT
6.7FT	30.1 FC	15.5 FT 13.2 FT
8.3FT	19.6 FC	19.1 FT 16.3 FT
10.0FT	13.5 FC	23.1 FT 19.7 FT

■ Vert. Spread: 98.1°
■ Horiz. Spread: 89.0°

12100-41-D13-I4-S-4
Illuminance at a Distance

	Center Beam FC	Beam Width
1.7FT	976 FC	3.8 FT 3.1 FT
3.3FT	259 FC	7.4 FT 5.9 FT
5.0FT	113 FC	11.3 FT 9.0 FT
6.7FT	62.8 FC	15.1 FT 12.1 FT
8.3FT	40.9 FC	18.7 FT 14.9 FT
10.0FT	28.2 FC	22.6 FT 18.0 FT

■ Vert. Spread: 96.9°
■ Horiz. Spread: 83.9°

12100-41-D9-I6-S-8
Illuminance at a Distance

	Center Beam FC	Beam Width
1.7FT	1446 FC	4 FT 3.1 FT
3.3FT	384 FC	7.8 FT 6.0 FT
5.0FT	167 FC	11.7 FT 9.1 FT
6.7FT	93.1 FC	15.7 FT 12.2 FT
8.3FT	60.6 FC	19.5 FT 15.2 FT
10.0FT	41.8 FC	23.5 FT 18.3 FT

■ Vert. Spread: 98.1°
■ Horiz. Spread: 89.0°

COLOR TEMPERATURE GUIDE



2700K

WARM
WHITE

friendly
personal
intimate

✓
HOMES
LIBRARIES
RESTAURANTS

3000K

SOFT WHITE
GLOW

soft
warm
pleasing

✓
HOMES
HOTEL ROOMS
LOBBIES
RETAIL STORES

3500K

NEUTRAL
GLOW

sociable
inviting
non-threatening

✓
EXECUTIVE OFFICES
RECEPTION AREAS
SUPERMARKETS

4000K

COOL WHITE
GLOW

neat
clean
efficient

✓
OFFICES
CLASSROOMS
MASS MERCHANDISERS
SHOWROOMS

5000K

DAYLIGHT
GLOW

bright
cool
alert

✓
GRAPHICS INDUSTRY
HOSPITALS
GALLERIES
BEAUTY SALONS