

FIXTURE SPECIFICATIONS

INTENDED USE

Our capsule luminaire features soft but powerful diffused lighting with a matte white finish. This diecast aluminum product is assembled in the USA. Ideal for residential, commercial, institutional or architectural interiors. Sections can be joined to form longer length products and includes hardware for continuous row mounting. Standard lengths are 4-feet and 8-feet.

DETAILS

Construction: Extruded aluminum die cast aluminum flat end caps

Lens: White acrylic diffuser | louver

Voltage: 50/60 Hz constant current 0-10V @ 120-277V, TRIAC & ELV @ 120V

Lumens: 128.38 lm/W

Dimming: 0-10V, TRIAC (Forward-phase), ELV (Reverse-phase)

Power Factor: +0.9

Operating Temperature: 4°F (-20°C) ~ 122°F (50°C).

Life: L70 - +60,000 hours

Warranty: 5 years carefree for parts & components (Labor not included)

Listings: UL / CUL listed

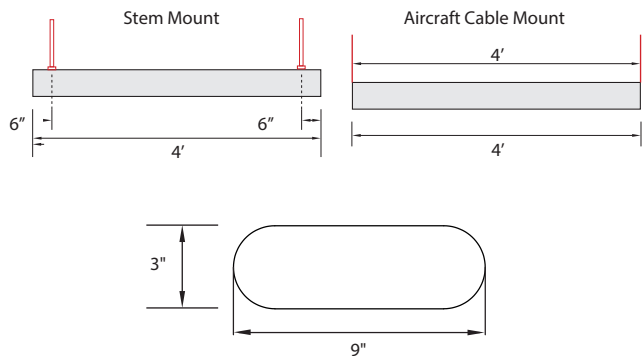

ORDERING INFORMATION Example: (12141-P-S-4-36W-D-27K-A-8-AC4-T-W)

Model	Type	Length	Wattage Lumens	Distribution	Color Temp	Finish	Shielding	CRI	Pendant Mounting	Ceiling Type	Cord Finish	Options	Optional Controls
12141	P Pendant	S Single Run	4' or 8'										
			Per 4 Foot Sections										
			36W 100% Direct Only 36 Watts 4724 lms	D100 2700K	27K² White	WH White	A White Acrylic Lens	8 80+	(Blank) None Required	T T-Bar	WH White	Blank No Options	Blank No Controls
		54W 25% Direct/75% Indirect 54 Watts 7035 lms	D25I75¹ 3000K	30K 3000K	SL Silver	L³ Louver	9 90+	AC4 4' Adjustable Aircraft Cable	H Hard	BK Black	EM5 5W Emergency Ballast	LV Lutron VIVE™ Wireless	
		81W 50% Direct/50% Indirect 81 Watts 10501 lms	D50I50¹ 3500K	35K 3500K	BK Black	AC8 8' Adjustable Aircraft Cable	EM8 8W Emergency Ballast	PH Philips EasySense™					
		D75I25¹ 75% Direct/25% Indirect	40K 4000K	XXXX Specify XXXX: Use RAL # found on Page 2	ACX Specify X in Feet (Max 30')	OS Occupancy Sensor w/ Daylight Harvesting	EN Siemens Enlightened™						
CR Continuous Run	Specify Run Length in Feet												
	D90I10¹ 90% Direct/10% Indirect 5000K	50K 5000K	ST2 2' Stem	DS Daylight Dimming Photo Sensor	AB Separate Dimming Control of Uplight and Downlight								
	ST4 4' Stem	STX Specify X in Feet (Max 8')											

¹ Only available for Pendant Mount
² Only available in 90+ CRI
³ Louver is only available for the 4' length

Alcon Lighting 12141 Architectural LED Linear Pendant Mount Direct Down Light

Available Finishes

Standard

	Matte White	RAL #9003
--	-------------	-----------

Set up fee and longer lead time will be applied on non-standard finishes.

Metropolitan

	Black	RAL #9011
	Silver	RAL #9022
	Urban Native	RAL #8025
	Military Green	RAL #6011
	Carmin	RAL #8028
	Chocolate Spice	RAL #8017
	Asher Grey	RAL #7004
	Tech Grey	RAL #7016
	Slate	RAL #7031
	Mason	RAL #7039

Vibrant

	Violet Dreams	RAL #4006
	Sangria Sunset	RAL #2004
	Deep Pink	RAL #4010
	Ruby Red	RAL #3027
	Island Sky	RAL #6027
	Sophia	RAL #5015
	Antique Spring	RAL #6019
	Daisy	RAL #1018
	Gun Metal	RAL #7024

Photometrics

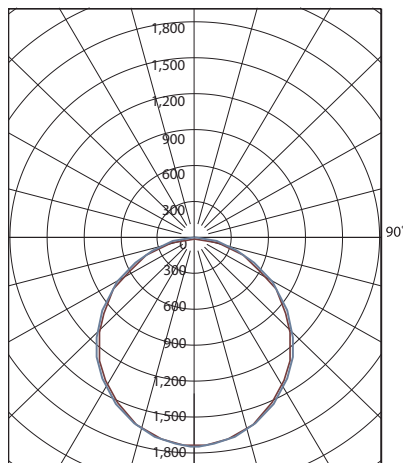

12141-4-54-D

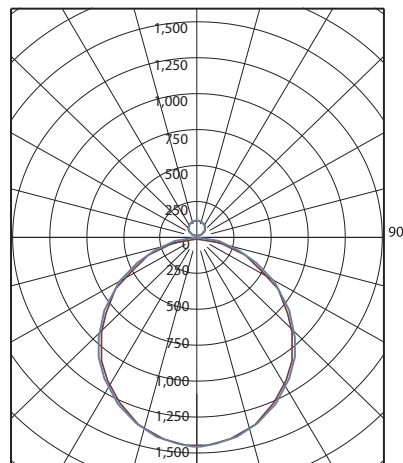

12141-4-54-D911

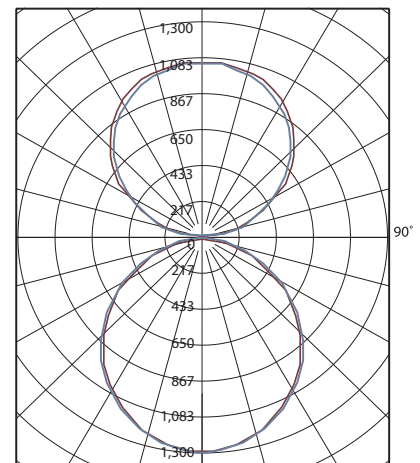

12141-4-36-DI

Photometrics

Direct

12141-4-36-D

Illuminance at a Distance

Center Beam FC Beam Width

1.7FT	399 FC	5.1 FT	4.9 FT
3.3FT	106 FC	9.9 FT	9.5 FT
5.0FT	46.2 FC	14.9 FT	14.4 FT
6.7FT	25.7 FC	20.0 FT	19.3 FT
8.3FT	16.8 FC	24.8 FT	23.9 FT
10.0FT	11.5 FC	29.9 FT	28.8 FT

- Vert. Spread: 112.4°
- Horiz. Spread: 110.5°

12141-4-81-D

Illuminance at a Distance

Center Beam FC Beam Width

1.7FT	888 FC	5.1 FT	4.9 FT
3.3FT	236 FC	9.9 FT	9.5 FT
5.0FT	103 FC	14.9 FT	14.4 FT
6.7FT	57.2 FC	20.0 FT	19.3 FT
8.3FT	37.2 FC	24.8 FT	23.9 FT
10.0FT	25.7 FC	29.9 FT	28.8 FT

- Vert. Spread: 112.4°
- Horiz. Spread: 110.5°

90% Direct / 10% Indirect

12141-4-36-D9I1

Illuminance at a Distance

Center Beam FC Beam Width

1.7FT	324 FC	5.0 FT	4.9 FT
3.3FT	85.9 FC	9.8 FT	9.4 FT
5.0FT	37.4 FC	14.8 FT	14.3 FT
6.7FT	20.8 FC	19.8 FT	19.1 FT
8.3FT	13.6 FC	24.5 FT	23.7 FT
10.0FT	9.35 FC	29.6 FT	28.6 FT

- Vert. Spread: 111.9°
- Horiz. Spread: 110.0°

12141-4-81-D9I1

Illuminance at a Distance

Center Beam FC Beam Width

1.7FT	778 FC	5.0 FT	4.9 FT
3.3FT	206 FC	9.8 FT	9.4 FT
5.0FT	89.9 FC	14.8 FT	14.3 FT
6.7FT	50.1 FC	19.8 FT	19.1 FT
8.3FT	32.6 FC	24.5 FT	23.7 FT
10.0FT	22.5 FC	29.6 FT	28.6 FT

- Vert. Spread: 111.9°
- Horiz. Spread: 110.0°

52% Direct/ 48% Indirect

12141-4-36-DI

Illuminance at a Distance

Center Beam FC Beam Width

1.7FT	310 FC	5.0 FT	4.9 FT
3.3FT	82.4 FC	9.7 FT	9.5 FT
5.0FT	35.9 FC	14.8 FT	14.4 FT
6.7FT	20.0 FC	19.8 FT	19.3 FT
8.3FT	13.0 FC	24.5 FT	23.9 FT
10.0FT	8.97 FC	29.5 FT	28.8 FT

- Vert. Spread: 111.8°
- Horiz. Spread: 110.5°

12141-4-81-DI

Illuminance at a Distance

Center Beam FC Beam Width

1.7FT	629 FC	5.0 FT	4.9 FT
3.3FT	167 FC	9.7 FT	9.5 FT
5.0FT	72.7 FC	14.8 FT	14.4 FT
6.7FT	40.5 FC	19.8 FT	19.3 FT
8.3FT	26.4 FC	24.5 FT	23.9 FT
10.0FT	18.2 FC	29.5 FT	28.8 FT

- Vert. Spread: 111.8°
- Horiz. Spread: 110.5°

Controls

Smart Sensors	Protocol	Compatible Networks	Occupancy	Daylight	Temperature Reporting	Communication to Luminaire
enlighted	Enlighted RF	Enlighted RF	Integrated	Integrated	Yes	Wireless
LUTRON	EcoSystem	Quantum, Energi Savr Node, Energi TriPak	Enabled	Enabled	No	Wired
vive	Lutron Clear Connect*	Lutron Vive System Network	Enabled	Enabled	No	Wireless
PHILIPS	ZigBee HA	Philips	Enabled	Enabled	No	Wired



Controls Installed on the Fixture



FCJS-010
Individual
Fixture Control

Fixture Will be Shipped LUTRON VIVE Enabled with LUTRON FCJS-010 0-10V Control Module Installed on the Fixture. Fixtures will be compatible with Lutron FC-SENSOR Occupancy/Daylight Sensor or FC-VSENSOR Vacancy/Daylight Sensor which can be Added in the Field for Remote Mounting. Fixture May be Controlled with any Vive control systems. Fixtures must be ordered with a 0-10V. Driver.



FCJS-ECO
Individual
Fixture Control

Fixture Will be Shipped LUTRON VIVE Enabled with LUTRON FCJS-ECO EcoSystem Control Module Control Module Installed on the Fixture. Fixtures will be compatible with Lutron FC-SENSOR Occupancy/Daylight Sensor or FC-VSENSOR Vacancy/Daylight Sensor which can be Added in the Field for Remote Mounting. Fixture May be Controlled with any Vive control systems. Fixtures must be ordered with a Lutron Driver.

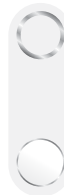

DFCSJ-OEM-OCC

Fixture Will be Shipped LUTRON VIVE Enabled with DFCSJ-OEM-OCC* Vive Integral Fixture Control (with Sensing) Installed on the Fixture. Fixture May be Controlled with any Vive control systems. Fixtures must be ordered with a DMX or Lutron EcoSystem Driver

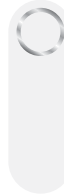

DFCSJ-OEM-RF

Fixture Will be Shipped LUTRON VIVE Enabled with LUTRON DFCSJ-OEM-RF* Vive Integral Fixture Control (RF Only) Installed on the Fixture. Fixture May be Controlled with any Vive control systems. Fixtures must be ordered with a DMX or Lutron EcoSystem Driver.

Controls Provided by Lutron



Vive Wireless Hub



DayLight
Sensor



Ceiling Mount
Occupancy/Daylight
Sensor



Ceiling Mount
Occupancy Sensor



Pico
Remote



Wall Mount
Switch



Wall Mount
Occupancy Sensor

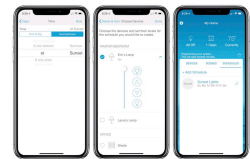

Lutron App

Controls



Fixture will be shipped with Leviton ZL027-N0W power control module installed on the fixture. Fixtures will be compatible with Leviton ZL00J-D0W sensor control module which can be added in the field for remote mounting. Fixture must be controlled with Leviton Intellect Keypad Room Controller, or Leviton Neuron App.



ZL027-N0W
Power control module



ZL00J-D0W
Sensor control module

Leviton Keypad



ZLDNK-1W



ZLDNK-2W



ZLDNK-4W



ZLDNK-8W

Intellect™ Keypad Room Controller (Required)

Leviton App

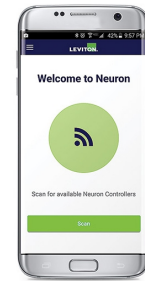

Neuron App



Philips EasySense sensors provide luminaire-level control with Occupancy sensing, Daylight harvesting, and Field task tuning.

Controls Installed on the Fixture



PHILIPS-XSR + SNS200

Fixture will be Shipped with EasySense SNS200 Sensor installed and PHILIPS-XSR driver. Fixture May Only be Controlled with Philips Field App or Wireless Switches.



SRB + SNS200

Fixture Will be Shipped with EasySense SNS200 Sensor installed and PHILIPS SRB Bridge. Fixture May Only be Controlled with Philips Field App or Wireless Switches or any 0-10V. Wall Box Dimmer.



Controls Provided by Philips



ZBT-S1AWH



ZBT-S2AWH

Ilumra Wireless Switches



PHILIPS-XSR + SNS200-CMP

Fixture will be Shipped Sensor Ready with PHILIPS-XSR driver and EasySense SNS200-CMP Sensor which is Included to be Remote Mounted. Fixture May Only be Controlled with Philips Field App or Wireless Switches



SRB + SNS200-CMP

Fixture Will be Shipped Sensor Ready with PHILIPS SRB Bridge and EasySense SNS200-CMP Sensor which is Included to be Remote Mounted. Fixture May Only be Controlled with Philips Field App or Wireless Switches or any 0-10V. Wall Box Dimmer.



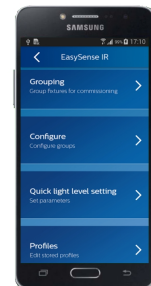

SRB

Fixture will be Shipped Sensor Ready with SRB Bridge. Fixture will be Compatible with EasySense Sensor SNS200-CMP which can be Added in the Field for Remote Mounting. Fixture May Only be Controlled with Philips Field App or Wireless Switches or any 0-10V. Wall Box Dimmer.



Philips Field App

MFG	Triac	ELV	0-10
	TG-600P	DVELV-303P	NTSTV
	LG-600P	SELV-300P	NFTV
	TGCL-153P	MAELV-600	DVSTV
	DV-600P	FAELV-500	
	DVCL-153P		
	S-603PG		
	CT-103P S-600P		
	6161	IPE04	IP710-DLZ
	6633-P	VPE06-1LZ	
	6683		
	6631-2		
	IPI06-1LZ		

COLOR TEMPERATURE GUIDE

