

FIXTURE SPECIFICATIONS

INTENDED USE

Built with a die-formed, corrosion-resistant steel channel with knockouts for versatile configuration and easy mounting, the pendant or surface-mount LED light strip offers efficient lighting in a compact design. The product yields energy savings with crisper brightness that's ideal for industrial, commercial and institutional interiors. The glossy finish is baked white enamel. The diffused lens is frosted in acrylic. Electrical specifications meet Class 1 or Class 2. Circuit voltage is 120-277 (50/60 Hz). Our premium product suits damp locations.

FEATURES

- Construction:** Die-formed steel channel with knock-outs for versatile configuration and easy mounting corrosion resistant
- Finish:** High-gloss baked white enamel
- Lens:** Frosted acrylic diffuser
- Electrical:** Meets Class 1 or Class 2 Circuit
- Voltage:** 120-277 (50/60 Hz)
- Dimming:** 0-10V 1-100%
- CRI:** 83+
- Efficiency:** 126 lm/W
- Power Factor:** +0.95
- THD:** <20
- Operating Temperature:** -20°C (-4°F) - 50°C (122°F)
- Life:** 50,000 Hours (L80)
- Warranty:** 5 Years
- Listings:** UL/cUL Listed and sabeled, DLC Listed, Suitable for damp locations

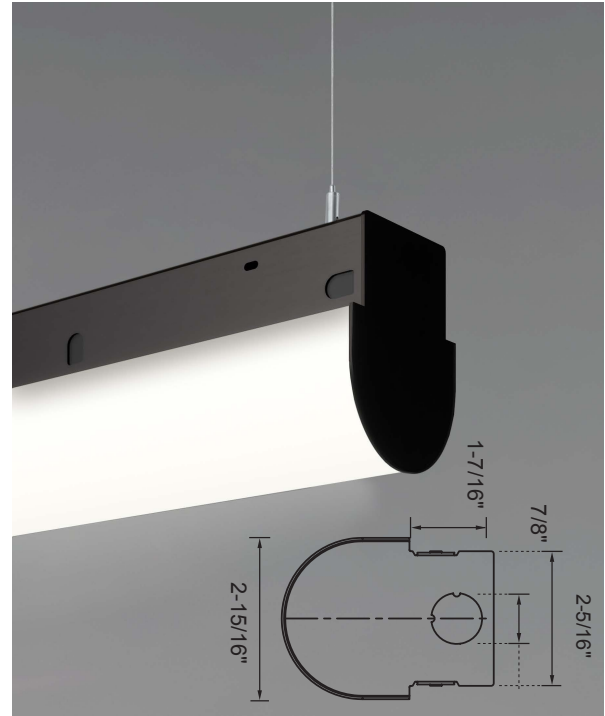

Alcon 12184 Chela Commercial-Grade Linear LED Pendant or Surface Light Strip

ORDERING INFORMATION Example: (12184-P-S4-D427-WH-30K-8-010-AC48-T-WH)

Model	Mount	Shape	Single Run		Wattage Lumen	Finish	Color Temp	CRI	Driver	Pendant Mounting	Pendant Ceiling Type	Pendant Cord/Stem Color	Options
			2', 4' or 8'	Cont. Run									
12184	Pendant S Surface	S CR Continuous Run	Specify Run Length in Feet	2 Foot	WH 27K ¹ SL 30K BK 35K RAL# 40K Specify 4000K RAL # 50K (Pg. 3) 5000K	27K ¹ 30K 35K 40K 50K	8 9 90+ CRI	010 Standard 010 1% TRI Triac (120V) ELV Electronic Low Voltage 050 Tunable White 0-10V	(Blank) AC48 48" Adjustable Aircraft Cable AC96 96" Adjustable Aircraft Cable ST24 24" Stem Mount Kit ST48 48" Stem Mount Kit	(Blank) T T-Bar Ceiling H Hard Ceiling SH Sloped Hard Ceiling	(Blank) WH White BK Black	EM5 5W Emergency Backup Battery EM8 8W Emergency Backup Battery EM16 16W Emergency Backup Battery DD Integrated Daylight Dimming Photosensor OS Integrated Occupancy Sensor	
				18 Watts 2433 Lumens									
				27 Watts 3941 Lumens									
				36 Watts 4944 Lumens									
				4 Foot									
				27 Watts 3726 Lumens									
	36 Watts 5005 Lumens												
	54 Watts 7316 Lumens												
	72 Watts 10006 Lumens												
	8 Foot												
	27 Watts 4019 Lumens												
	36 Watts 5286 Lumens												
54 Watts 7771 Lumens													
72 Watts 10390 Lumens													
108 Watts 14030 Lumens													
144 Watts 18704 Lumens													

¹ Must be paired with 90+ CRI
² Must be paired with 050 Driver



END VIEW

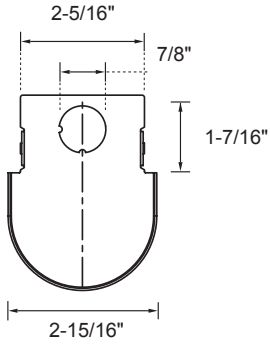

Specifications: 12184-2 Weight: 4.7 lbs (2.13 kg) Specifications: 12184-4 Weight: 6.9 lbs (3.13 kg) Specifications: 12184-8 Weight: 10.43 lbs (4.73 kg)

TOP VIEW

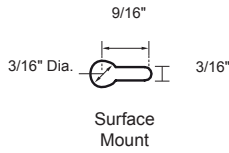
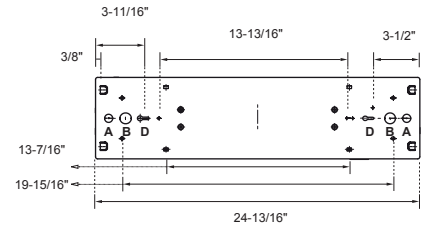

- A : 11/16" Dia.
- B : 7/8" Dia.
- C : 2" Dia.
- D : 3/16" Dia.

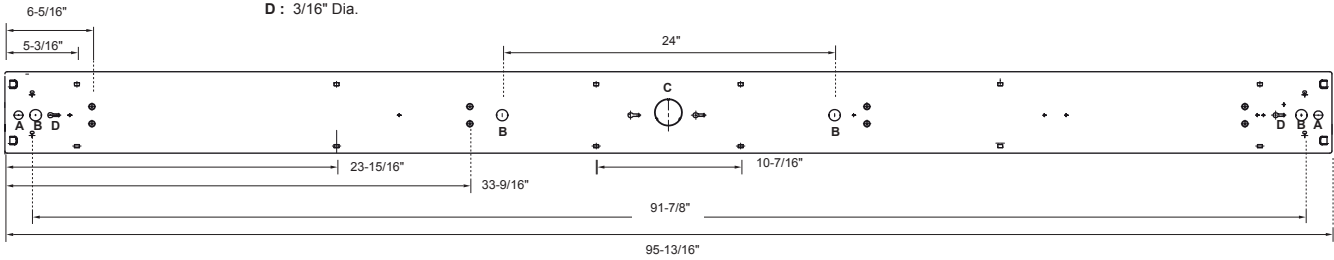
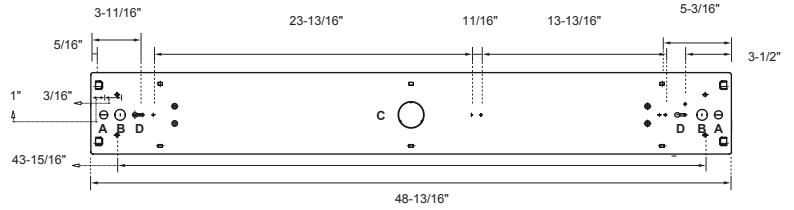

SIDE VIEW

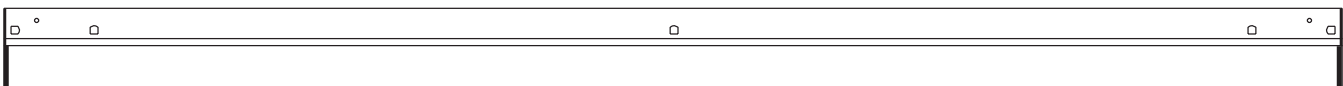
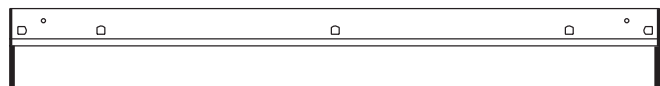
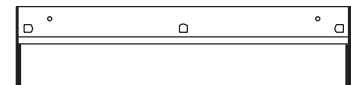

AVAILABLE FINISHES

Standard

	Semi Glossy White	RAL #9003
--	-------------------	-----------

Set up fee and longer lead time will be applied on non-standard finishes.





Metropolitan

	Black	RAL #9011
	Silver	RAL #9022
	Urban Native	RAL #8025
	Military Green	RAL #6011
	Carmin	RAL #8028
	Chocolate Spice	RAL #8017
	Asher Grey	RAL #7004
	Tech Grey	RAL #7016
	Slate	RAL #7031
	Mason	RAL #7039

Vibrant

	Violet Dreams	RAL #4006
	Sangria Sunset	RAL #2004
	Deep Pink	RAL #4010
	Ruby Red	RAL #3027
	Island Skye	RAL #6027
	Sophia	RAL #5015
	Antique Spring	RAL #6019
	Daisy	RAL #1018
	Gun Metal	RAL #7024

CONTROLS

Smart Sensors	Protocol	Compatible Networks	Occupancy	Daylight	Temperature Reporting	Communication to Luminaire
	Enlighted RF	Enlighted RF	Integrated	Integrated	Yes	Wireless
	EcoSystem	Quantum, Energi Savr Node, Energi TriPak	Enabled	Enabled	No	Wired
	Lutron Clear Connect®	Lutron Vive System Network	Enabled	Enabled	No	Wireless
	ZigBee HA	Philips	Enabled	Enabled	No	Wired

LUTRON

Controls Installed on the Fixture

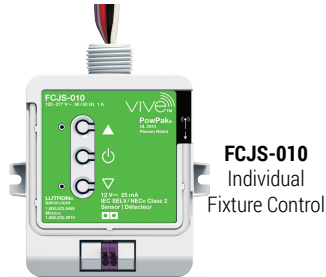

FCJS-010
Individual
Fixture Control

Fixture Will be Shipped LUTRON VIVE Enabled with LUTRON FCJS-010 0-10V Control Module Installed on the Fixture. Fixtures will be compatible with Lutron FC-SENSOR Occupancy/Daylight Sensor or FC-VSENSOR Vacancy/Daylight Sensor which can be Added in the Field for Remote Mounting. Fixture May be Controlled with any Vive control systems. Fixtures must be ordered with a 0-10V. Driver.

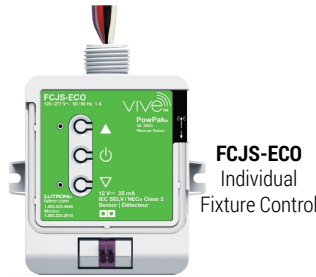

FCJS-ECO
Individual
Fixture Control

Fixture Will be Shipped LUTRON VIVE Enabled with LUTRON FCJS-ECO EcoSystem Control Module Installed on the Fixture. Fixtures will be compatible with Lutron FC-SENSOR Occupancy/Daylight Sensor or FC-VSENSOR Vacancy/Daylight Sensor which can be Added in the Field for Remote Mounting. Fixture May be Controlled with any Vive control systems. Fixtures must be ordered with a Lutron Driver.

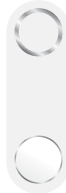

DFCSJ-OEM-OCC

Fixture Will be Shipped LUTRON VIVE Enabled with DFCSJ-OEM-OCC* Vive Integral Fixture Control (with Sensing) Installed on the Fixture. Fixture May be Controlled with any Vive control systems. Fixtures must be ordered with a DMX or Lutron EcoSystem Driver

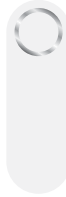

DFCSJ-OEM-RF

Fixture Will be Shipped LUTRON VIVE Enabled with LUTRON DFCSJ-OEM-RF* Vive Integral Fixture Control (RF Only) Installed on the Fixture. Fixture May be Controlled with any Vive control systems. Fixtures must be ordered with a DMX or Lutron EcoSystem Driver.

Controls Provided by Lutron



Vive Wireless Hub



DayLight
Sensor



Ceiling Mount
Occupancy/Daylight
Sensor



Ceiling Mount
Occupancy Sensor



Pico
Remote



Wall Mount
Switch



Wall Mount
Occupancy Sensor

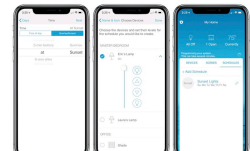

Lutron App

LEVITON

Fixture will be shipped with Leviton ZL027-N0W power control module installed on the fixture. Fixtures will be compatible with Leviton ZL00J-D0W sensor control module which can be added in the field for remote mounting. Fixture must be controlled with Leviton Intellect Keypad Room Controller, or Leviton Neuron App.



ZL027-N0W
Power control module



ZL00J-D0W
Sensor control module

Leviton Keypad



ZLDNK-1W



ZLDNK-2W



ZLDNK-4W



ZLDNK-8W

Intellect™ Keypad Room
Controller (Required)

Leviton App

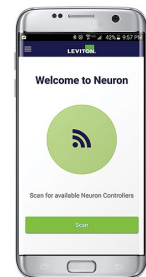

Neuron App



Philips EasySense sensors provide luminaire-level control with Occupancy sensing, Daylight harvesting, and Field task tuning.

Controls Installed on the Fixture

Controls Provided by Philips



PHILIPS-XSR + SNS200

Fixture will be Shipped with EasySense SNS200 Sensor installed and PHILIPS-XSR driver. Fixture May Only be Controlled with Philips Field App or Wireless Switches.



SRB + SNS200

Fixture Will be Shipped with EasySense SNS200 Sensor installed and PHILIPS SRB Bridge. Fixture May Only be Controlled with Philips Field App or Wireless Switches or any 0-10V. Wall Box Dimmer.



ZBT-S1AWH



ZBT-S2AWH

Illumra Wireless Switches



PHILIPS-XSR + SNS200-CMP

Fixture will be Shipped Sensor Ready with PHILIPS-XSR driver and EasySense SNS200-CMP Sensor which is Included to be Remote Mounted. Fixture May Only be Controlled with Philips Field App or Wireless Switches

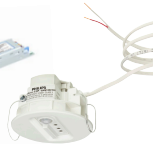

SRB + SNS200-CMP

Fixture Will be Shipped Sensor Ready with PHILIPS SRB Bridge and EasySense SNS200-CMP Sensor which is Included to be Remote Mounted. Fixture May Only be Controlled with Philips Field App or Wireless Switches or any 0-10V. Wall Box Dimmer.



SRB

Fixture will be Shipped Sensor Ready with SRB Bridge. Fixture will be Compatible with EasySense Sensor SNS200-CMP which can be Added in the Field for Remote Mounting. Fixture May Only be Controlled with Philips Field App or Wireless Switches or any 0-10V. Wall Box Dimmer.

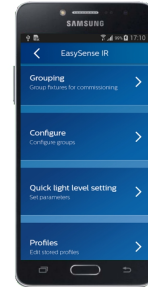

Philips Field App

COMPATIBLE DIMMERS

MFG	Triac	ELV	0-10
	TG-600P	DVELV-303P	NTSTV
	LG-600P	SELV-300P	NFTV
	TGCL-153P	MAELV-600	DVSTV
	DV-600P	FAELV-500	
	DVCL-153P		
	S-603PG		
	CT-103P		
	S-600P		
	6161	IPE04	IP710-DLZ
	6633-P	VPE06-1LZ	
	6683		
	6631-2		
	IPI06-1LZ		

COLOR TEMPERATURE GUIDE



2700K

**WARM
WHITE**

friendly
personal
intimate

HOMES
LIBRARIES
RESTAURANTS ✓

3000K

**SOFT WHITE
GLOW**

soft
warm
pleasing

HOMES
HOTEL ROOMS
LOBBIES
RETAIL STORES ✓

3500K

**NEUTRAL
GLOW**

sociable
inviting
non-threatening

EXECUTIVE OFFICES
RECEPTION AREAS
SUPERMARKETS ✓

4000K

**COOL WHITE
GLOW**

neat
clean
efficient

OFFICES
CLASSROOMS
MASS MERCHANDISERS
SHOWROOMS ✓

5000K

**DAYLIGHT
GLOW**

bright
cool
alert

GRAPHICS INDUSTRY
HOSPITALS
GALLERIES
BEAUTY SALONS ✓

PHOTOMETRICS

12184-2-D218-30K

Illuminance at a Distance

	Center Beam FC	Beam Width	
1.7FT	286 FC	2.8 FT	3.4 FT
3.3FT	75.9 FC	5.4 FT	6.5 FT
5.0FT	33.1 FC	8.1 FT	9.9 FT
6.7FT	18.4 FC	10.9 FT	13.3 FT
8.3FT	12.0 FC	13.5 FT	16.4 FT
10.0FT	8.27 FC	16.3 FT	19.8 FT

- Vert. Spread: 78.2°
- Horiz. Spread: 89.5°

12184-2-D236-30K

Illuminance at a Distance

	Center Beam FC	Beam Width	
1.7FT	557 FC	4.5 FT	5.9 FT
3.3FT	148 FC	8.7 FT	11.4 FT
5.0FT	64.3 FC	13.2 FT	17.3 FT
6.7FT	35.8 FC	17.6 FT	23.1 FT
8.3FT	23.3 FC	21.8 FT	28.7 FT
10.0FT	16.1 FC	26.3 FT	34.5 FT

- Vert. Spread: 105.5°
- Horiz. Spread: 119.9°

12184-4-D427-30K

Illuminance at a Distance

	Center Beam FC	Beam Width	
1.7FT	436 FC	4.5 FT	5.9 FT
3.3FT	116 FC	8.7 FT	11.4 FT
5.0FT	50.4 FC	13.2 FT	17.3 FT
6.7FT	28.1 FC	17.6 FT	23.1 FT
8.3FT	18.3 FC	21.8 FT	28.7 FT
10.0FT	12.6 FC	26.3 FT	34.5 FT

- Vert. Spread: 105.5°
- Horiz. Spread: 119.9°

12184-4-D454-30K

Illuminance at a Distance

	Center Beam FC	Beam Width	
1.7FT	846 FC	4.5 FT	5.9 FT
3.3FT	224 FC	8.7 FT	11.4 FT
5.0FT	97.8 FC	13.2 FT	17.3 FT
6.7FT	54.4 FC	17.6 FT	23.1 FT
8.3FT	35.5 FC	21.8 FT	28.7 FT
10.0FT	24.4 FC	26.3 FT	34.5 FT

- Vert. Spread: 105.5°
- Horiz. Spread: 119.9°

12184-8-D872-30K

Illuminance at a Distance

	Center Beam FC	Beam Width	
1.7FT	1,205 FC	4.5 FT	5.9 FT
3.3FT	320 FC	8.7 FT	11.4 FT
5.0FT	139 FC	13.2 FT	17.3 FT
6.7FT	77.6 FC	17.6 FT	23.1 FT
8.3FT	50.5 FC	21.8 FT	28.7 FT
10.0FT	34.8 FC	26.3 FT	34.5 FT

- Vert. Spread: 105.5°
- Horiz. Spread: 119.9°

12184-8-D8108-30K

Illuminance at a Distance

	Center Beam FC	Beam Width	
1.7FT	1,645 FC	2.8 FT	3.4 FT
3.3FT	437 FC	5.4 FT	6.5 FT
5.0FT	190 FC	8.1 FT	9.9 FT
6.7FT	160 FC	10.9 FT	13.3 FT
8.3FT	69.0 FC	13.5 FT	16.4 FT
10.0FT	47.5 FC	16.3 FT	19.8 FT

- Vert. Spread: 78.2°
- Horiz. Spread: 89.5°